

# ADVANCED 4/8 PORT DVI-D MATRIX SECURE KVM SWITCH

USM-2S0-3M1

REV: 1.00

DATE: 04/03/2018

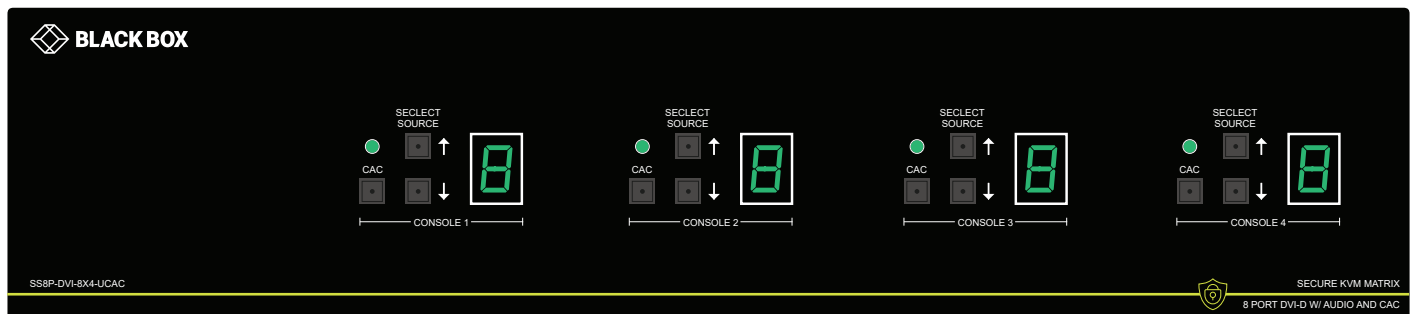

## MODELS:

- SS4P-DVI-4X2-UCAC      4-Port Secure DVI-D Matrix KVM Switch with Audio and CAC Support (2 Users)
- SS4P-DVI-4X4-UCAC      4-Port Secure DVI-D Matrix KVM Switch with Audio and CAC Support (4 Users)
- SS8P-DVI-8X2-UCAC      8-Port Secure DVI-D Matrix KVM Switch with Audio and CAC Support (2 Users)
- SS8P-DVI-8X4-UCAC      8-Port Secure DVI-D Matrix KVM Switch with Audio and CAC Support (4 Users)

---

## TABLE OF CONTENTS

TECHNICAL SPECIFICATIONS _____	3
WHAT'S IN THE BOX? _____	4
SECURITY FEATURES _____	4
SECURE KVM MATRIX FRONT AND REAR _____	4
INSTALLATION _____	6
CAC INSTALLATION: COMMON ACCESS CARD, SMART CARD READER _____	9
CAC PORT CONFIGURATION _____	9
AUDITING: Dumping the Event Log via User Menu Options _____	10
RESET: Restore Factory Default _____	10
LED's BEHAVIOR _____	11
SYSTEM OPERATION _____	12
TROUBLESHOOTING _____	12
TECHNICAL SUPPORT _____	12
LIMITED WARRANTY STATEMENT _____	13



TECHNICAL SPECIFICATIONS

VIDEO		
Format	DVI-Dual Link	
Host Interface	SS4P-DVI-4X2-UCAC / SS4P-DVI-4X4-UCAC	(4) DVI-D 29-pin (female)
	SS8P-DVI-8X2-UCAC / SS8P-DVI-8X4-UCAC	(8) DVI-D 29-pin (female)
User Console Interface	SS8P-DVI-8X2-UCAC / SDVN-42X	(2) DVI-D 29-pin (female)
	SS8P-DVI-8X4-UCAC / SS4P-DVI-4X4-UCAC	(4) DVI-D 29-pin (female)
Max Resolution	1080p and 4K/30Hz with HDMI adapter	
DDC	5 volts p-p (TTL)	
Input Equalization	Automatic	
Input Cable Length	Up to 20 ft.	
Output Cable Length	Up to 20 ft.	
USB		
Signal Type	USB 1.1 and 1.0 Keyboard and Mouse only. USB 2.0 for CAC connection.	
Type A to B	SS4P-DVI-4X2-UCAC / SS4P-DVI-4X4-UCAC	(8)
	SS8P-DVI-8X2-UCAC / SS8P-DVI-8X4-UCAC	(16)
User Console Interface	(2) / (4) Dual USB Type-A for K/M connection	
	(2) / (4) Single USB Type-A for CAC connection	
AUDIO		
Input	(4) / (8) Connector Stereo 3.5mm Female	
Output	(2) / (4) Connector Stereo 3.5mm Female	
POWER		
Power Requirements	12V DC, 3A (minimum) power adapter with center-pin positive polarity	
ENVIRONMENT		
Operating Temp	32° to 104° F (0° to 40° C)	
Storage Temp	-4° to 140° F (-20° to 60° C)	
Humidity	0-80% RH, non-condensing	
CERTIFICATIONS		
Security Accreditation	Common Criteria Validated To NIAP, Protection Profile PSS Ver. 3.0	
OTHER		
Emulation	Keyboard, Mouse & Video EDID	
Control	Front Panel Buttons	

**WHAT'S IN THE BOX?**

Secure KVM Matrix Unit	4/8-Port Single-Head Secure DVI-D Secure KVM Matrix Switch
PS12VDC3A	Desktop power supply 100-240V, 12VDC 3A
User Manual	

**SECURITY FEATURES**

**ANTI-TAMPER SWITCHES**

Each model is equipped with internal Anti-Tamper switches, which sense attempts to open the device enclosure. Once the system identifies such an attempt, all the front panel LED's will flash rapidly and the unit will become useless by shutting off connection with all attached PCs and peripherals disabling any functionality.

**TAMPER-EVIDENT SEAL**

The enclosure of the unit is protected with a tamper-evident seal to provide a visual evidence if the unit has been opened.

**PROTECTED FIRMWARE**

The controller of the unit has a special protection feature that prevents reprogramming or reading the firmware.

**HIGH ISOLATION ON USB CHANNELS**

Opto-isolators are used in the unit to keep USB data paths electrically isolated from each other, providing high isolation and preventing data leakage between ports.

**SECURE EDID EMULATION**

The unit prevents unwanted and unsecure data to be transmitted through the DDC lines by means of secure EDID learning and emulation.

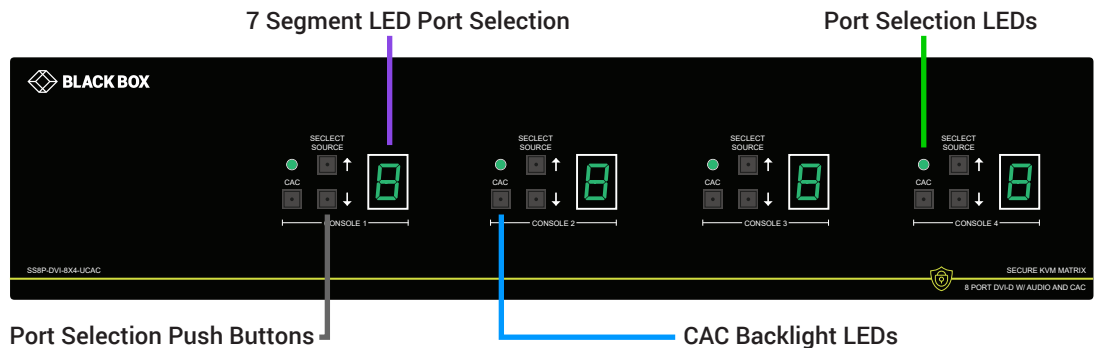

Figure 4-1: SS8P-DVI-8X4-UCAC Front panel

8-Port DVI-D Matrix Secure KVM Switch with Audio, KB/Mouse USB Emulation and CAC Support (4 Users)

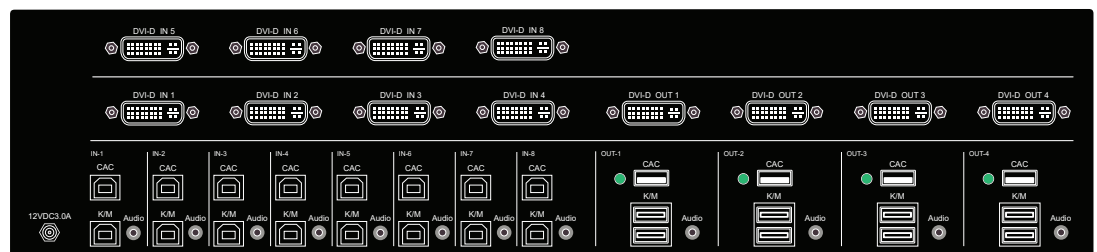

Figure 4-2: SS8P-DVI-8X4-UCAC Rear panel

8-Port Secure DVI-D Matrix Secure KVM Switch with Audio, KB/Mouse USB Emulation and CAC Support (2 Users)

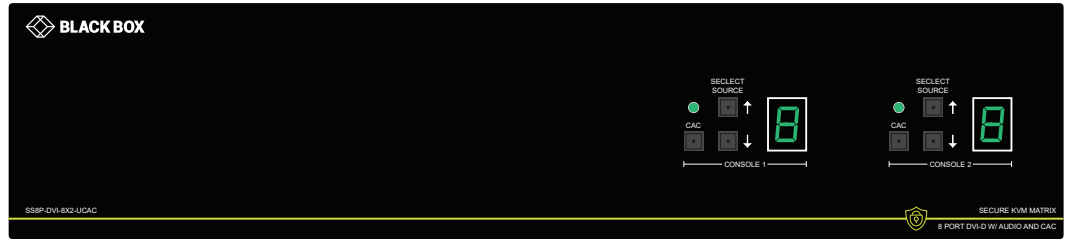

Figure 5-1: SS8P-DVI-8X2-UCAC Front panel

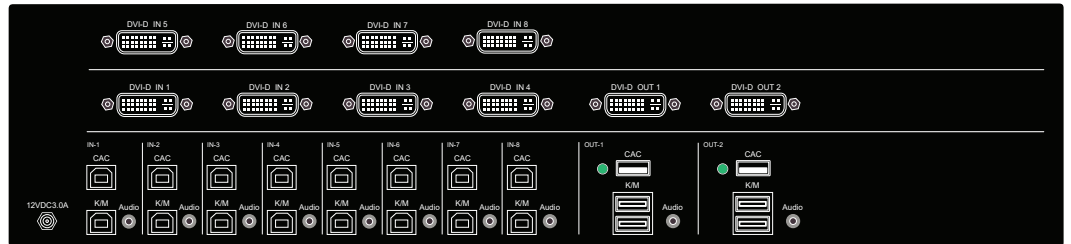

Figure 5-2: SS8P-DVI-8X2-UCAC Rear panel

4-Port DVI-D Matrix Secure KVM Switch with Audio, KB/Mouse USB Emulation and CAC Support (4 Users)

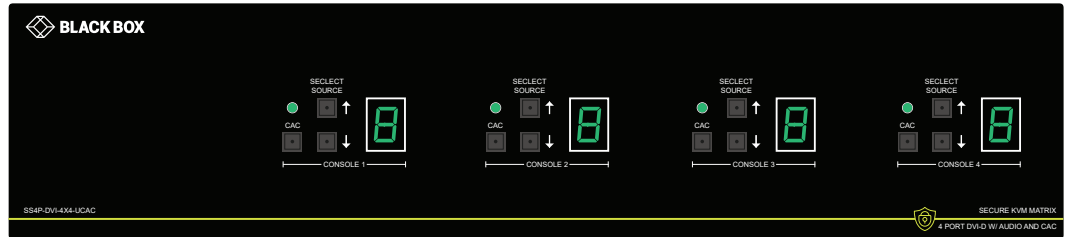

Figure 5-3: SS8P-DVI-4X4-UCAC Front panel

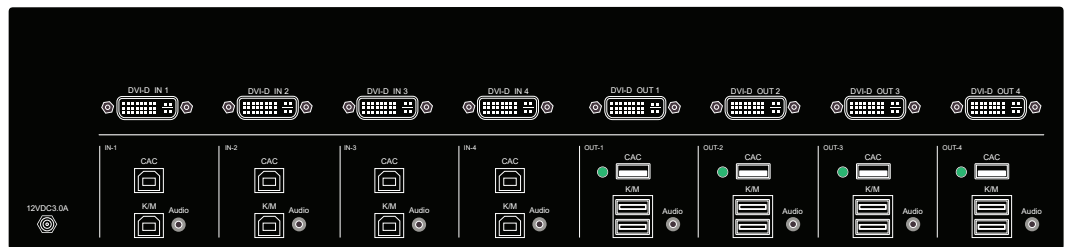

Figure 5-4: SS8P-DVI-4X4-UCAC Rear panel

4-Port DVI-D Matrix Secure KVM Switch with Audio, KB/Mouse USB Emulation and CAC Support (2 Users)

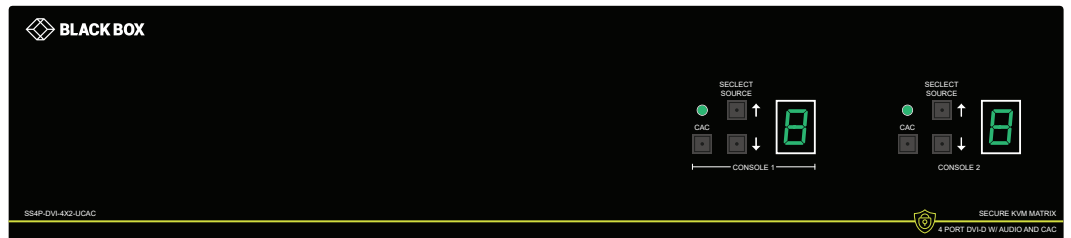

Figure 5-5: SS8P-DVI-4X2-UCAC Front panel

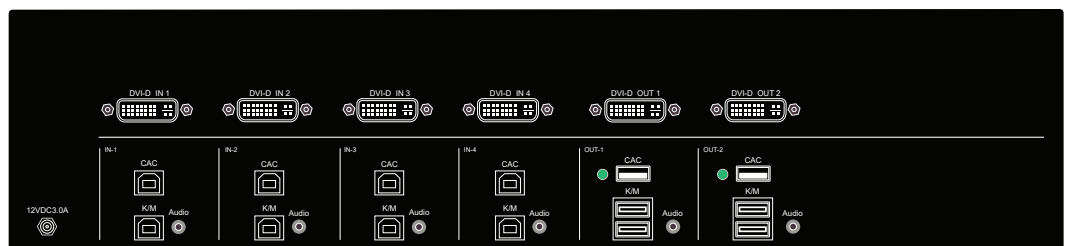

Figure 5-6: SS8P-DVI-4X2-UCAC Rear panel

## INSTALLATION

### SYSTEM REQUIREMENTS

1. Black Box Secure PSS is compatible with standard personal/portable computers, servers or thin-clients, running operating systems such as Windows or Linux.
2. The peripheral devices that are supported by the Secure KVM Switch are listed in the following table:

Console Port	Authorized Devices
Keyboard	Wired keyboard and keypad without internal USB hub or composite device functions, unless the connected device has at least one endpoint which is a keyboard or mouse HID class, KVM/KM extender.
Audio out	Analog amplified speakers, Analog headphones, Digital audio appliance.
Mouse / Pointing Device	Any wired mouse or trackball without internal USB hub or composite device functions, Touch-screen, Multi-touch or digitizer, KVM/KM extender.
User Authentication Device	Smart-card reader, PIV/CAC reader, Token or Biometric reader*

\*TOE - P models only

Table 6-1

## INSTALLATION

Single-Head Units:

1. Ensure that power is turned off or disconnected from the unit and the computers.
2. Use a DVI cable to connect the DVI output port from each computer to the corresponding DVI-D IN ports of the unit.
3. Use a USB cable (Type-A to Type-B) to connect a USB port on each computer to the respective USB ports of the unit.
4. Optionally connect a stereo audio cable (3.5mm to 3.5mm) to connect the audio output of the computers to the AUDIO IN ports of the unit.
5. Connect monitors to the DVI-D OUT console port of the unit using a DVI cables.
6. Connect a USB keyboard and mouse in the two USB console ports.
7. Optionally connect stereo speakers to the AUDIO OUT port of the unit.
8. Optionally connect CAC (COMMON ACCESS CARD, SMART CARD READER) to the CAC port in the user console interface.
9. Finally, power on the Secure KVM Switch by connecting a 12VDC power supply to the power connector, and then turn on all the computers.

**Note:** The computer connected to port 1 will always be selected by default after power up.

**Note:** You can connect up to 8 computers to the 8 port Secure KVM Matrix Switch.

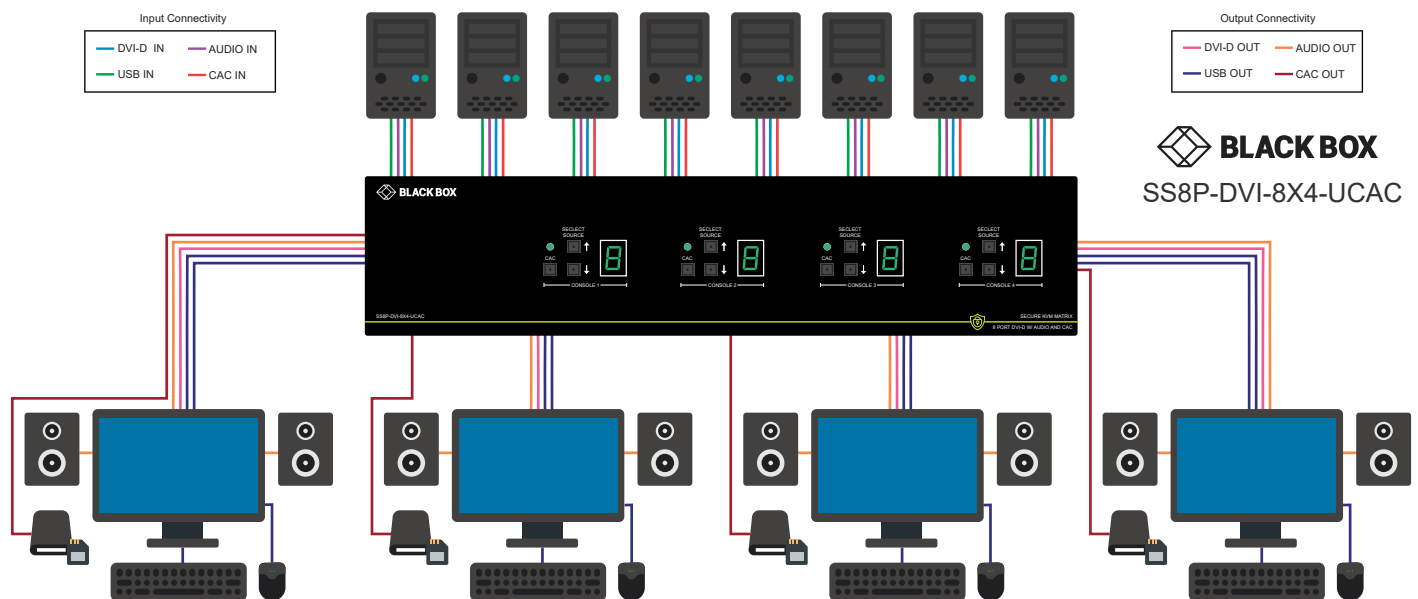

Figure 7-1: SS8P-DVI-8X4-UCAC

### IMPORTANT WARNINGS - FOR SECURITY REASONS:

- This product does not support wireless devices. Do not attempt to use a wireless keyboard or a wireless mouse with this product.
- This product does not support keyboards with integrated USB hubs or USB ports. Only use standard (HID) USB keyboards with this device.
- This product does not support microphone audio input or line input. Do not connect any microphones or headsets with microphones to this device.
- Connection of authentication devices (CAC) with external power sources is prohibited.

## INSTALLATION (Continued)

### EDID Learn:

The Secure KVM Switch is designed to learn the connected monitor's EDID upon power up. In the event of connecting a new monitor to the Secure KVM Switch, a power recycle is required.

The Secure KVM Switch will indicate to the user the EDID learn process by flashing the front panel's server signal.

The monitor must be connected to the video output connector "1" located in the console space at the back of the Secure KVM Switch during the EDID learn process.

If the read EDID from the connected monitor is identical to the current stored EDID in the Secure KVM Switch then the EDID learn function will be skipped.



## CAC (COMMON ACCESS CARD, SMART CARD READER)

### INSTALLATION

The following steps are intended for the system administrator or IT manager only.

If you have the optional CAC ports there will be 2 ports on a 2 host ports Secure KVM Switch and 4 ports on a 4 host port-Secure KVM Switch. CAC connection to the computer requires a USB cable connection separate from the keyboard and mouse. This allows the CAC to be connected independently from the keyboard and mouse. It also allows the user to select whether CAC for a certain computer is supported or not.

1. Ensure that power is turned off or disconnected from the unit and the computer.
2. Use a USB cable (Type-A to Type-B) to connect a USB port on a computer to its respective CAC USB ports on the Secure KVM Switch. Do not connect the USB cable if CAC functionality is not needed for that computer.
3. Connect a CAC (smart card reader) to the CAC port in the user console interface.
4. Power on the Secure KVM Switch by connecting a 12VDC power supply to the power connector, and then turn on all the computers.
5. To disable CAC for any channel (all CAC ports are enabled as default), use the front panel buttons to switch the Secure KVM Switch to the channel whose CAC mode you wish to change. Once the channel is selected, the button LED for this specific channel should be on (CAC port enabled). Press and hold the button for 3 seconds until the button LED turns off. The CAC port is now disabled for this channel.
6. To enable CAC for any channel, use the front panel buttons to switch the Secure KVM Switch to the channel whose CAC mode you wish to change. Once the channel is selected, the button LED for this specific channel should be off (CAC port disabled). Press and hold the button for 3 seconds until the button LED turns on. The CAC port is now enabled for this channel.

### CAC PORT CONFIGURATION

The following steps are intended for the system administrator and operators (users).

**Note:** Only one computer connected to port 1 is required for this operation

CAC port Configuration is an optional feature, allowing registration of any USB peripheral to operate with the Secure KVM Switch. Only one peripheral can be registered and only the registered peripheral will operate with the Secure KVM Switch. By default, when no peripheral is registered, the Secure KVM Switch will operate with any Smart Card Reader.

#### Configure the CAC Port via User Menu Options

1. Open the Administration and Security Management Program.
2. Using the keyboard, press the Alt key twice and type "cnfg".
3. At this stage the mouse connected to the Secure KVM Switch will stop functioning.
4. Enter the default username "user" and press Enter.
5. Enter the default password "12345" and press Enter.
6. Select option 2 from the menu on your screen and press Enter.
7. Connect the peripheral device to be registered to the CAC USB port in the console side of the Secure KVM Switch and wait until the Secure KVM Switch is reading the new peripheral information.
8. The Secure KVM Switch will list the information of the connected peripheral on the screen and buzz 3 times when registration is completed.

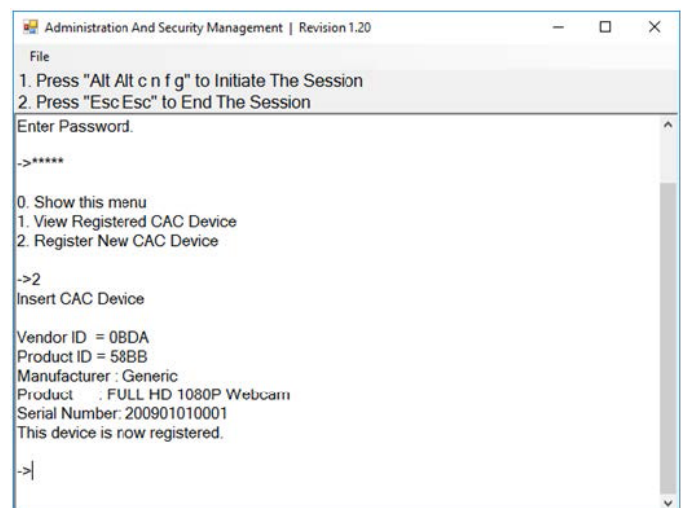

Figure 9-1 User Menu

## AUDITING: Dumping the Event Log via User Menu Options

The following steps are intended for the system administrator.

**Note:** Only one computer connected to port 1 is required for this operation

The Event Log is a detailed report of critical activities stored in the Secure KVM Switch or Secure KVM Switch memory. A comprehensive feature list and guidance for Administration and Security Management Tools can be found in the Administrator's Guide available for download from: <https://www.blackbox.com/NIAP3/documentation>

To view or dump the Event Log:

1. Open the Administration and Security Management Program
2. Using the keyboard, press the Alt key twice and type "cnfg"
3. Enter the default admin name "admin" and press Enter.
4. Enter the default password "12345" and press Enter.
5. Request a Log Dump by selecting option 5 in the menu. (Shown in Figure 10-1)

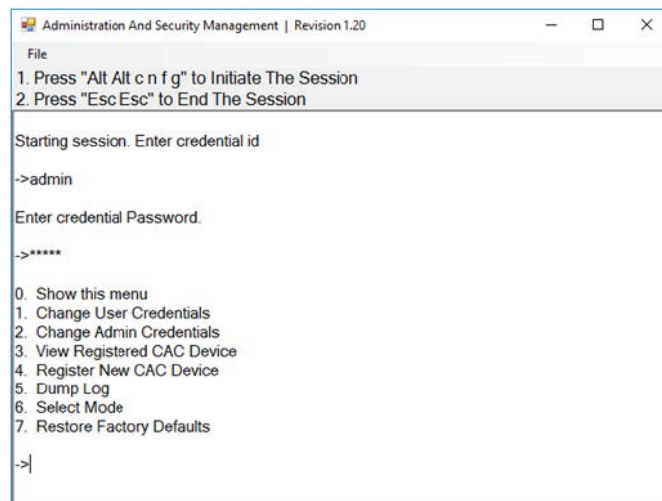

Figure 10-1

\* See Administration and Security Management Tool Guidance for detailed information.

## RESET: Restore Factory Defaults

The following steps are intended for the system administrator.

**Note:** Only one computer connected to port 1 is required for this operation

Restore Factory Defaults will reset all settings on the Secure KVM Switch to their original state

- Secure KVM Switch mode
- CAC port registration will be removed
- Secure KVM Switch settings will be reset to factory defaults

To Restore Factory Defaults via User Menu Options:

1. Open the Administration and Security Management Program
2. Using the keyboard, press the Alt key twice and type "cnfg"
3. Enter the default admin name "admin" and press Enter.
4. Enter the default password "12345" and press Enter.
5. Select option 7 from the menu on your screen and press enter. (Menu shown in Figure 10-1)

\* See Administration and Security Management Tool Guidance for detailed information.

## LED's BEHAVIOR

User Console Interface – Display LED:

#	Status	Description
1	Off	Monitor is not connected
2	On	Monitor is connected
3	Flashing	EDID problem – Learn EDID to fix the problem

User Console Interface – CAC LED:

#	Status	Description
1	Off	CAC is not connected
2	On	Authorized and functional CAC is connected
3	Flashing	Non-CAC peripheral is connected

Front Panel – Port Selection LED's:

#	Status	Description
1	Off	Non-selected port
2	On	Selected port
3	Flashing	EDID learn in process

Front Panel – CAC Selection LED's:

#	Status	Description
1	Off	CAC port is disabled or non-selected port
2	On	CAC port is enabled
3	Flashing	EDID learn in process

Front Panel – Port and CAC Selection LED's:

#	Status	Description
1	All Flashing	Connected peripheral to keyboard or mouse console ports is rejected

EDID Learn - Front Panel LED's:

All LED's are turned on for 1 second. Then:

- Port 1 LED's will flash until the end of the process.

### **IMPORTANT!**

If all the Front Panel LED's are flashing and the buzzer is beeping, the Secure KVM Switch has been **TAMPERED** with and all functions are permanently disabled. Please contact Black Box technical support at [info@blackbox.com](mailto:info@blackbox.com)

If all Front Panel LED's are on and not flashing, the POWER UP SELF TEST has failed and all functions are disabled. Check if any of the front panel port selection buttons are jammed. In this case, release the jammed button and recycle the power. If power up self test is still failing, please contact Black Box technical support at [info@blackbox.com](mailto:info@blackbox.com)

---

## SYSTEM OPERATION

### Front Panel Control

To switch to an input port, simply push the desired input button on the front-panel of the Secure KVM Switch. If an input port is selected, the LED of that port will turn on.

## TROUBLESHOOTING

### No Power

- Make sure that the power adapter is securely connected to the power connector of the unit.
- Check the output voltage of the power supply and make sure that the voltage value is around 12VDC.
- Replace the power supply.

### Flashing LEDs in the Front Panel with clicking sound

- Reboot the unit. If the error persists then there is a malfunction or wrong input connections at the K/M ports.
- Verify both Keyboard and Mouse connections are USB 1.0 or 1.1.
- Only USB Keyboard or Mouse can be connected in the designated K/M ports.

### Flashing USB LED

- Make sure that the correct peripheral device is connected to the correct port of the Secure KVM.
- Check to see that the K/M USB cable is connected to the K/M port on the back of the unit.
- Check to see that the CAC USB cable is connected to the CAC port on the back of the unit.

### No Video

- Check if all the video cables are connected properly.
- Connect the computer directly to the monitor to verify that your monitor and computer are functioning properly.
- Restart the computers

### Keyboard is not working

- Check if the keyboard is properly connected to the unit.
- Check if the USB cables connecting the unit and the computers are properly connected.
- Try connecting the USB on the computer to a different port.
- Make sure that the keyboard works when directly connected to the computer.
- Replace the keyboard.

**Note:** The NUM, CAPS, and SCROLL Lock LED indicators on the keyboard are not supposed to light up if connected to the Secure KVM Switch.

### Mouse is not working

- Check if the mouse is properly connected to the unit.
- Try connecting the USB on the computer to a different port.
- Make sure that the mouse works when directly connected to the computer.
- Replace the mouse.

### No Audio

- Check if all the audio cables are connected properly.
- Connect the speakers directly to the computer to verify that the speakers and the computer audio are functioning properly.
- Check the audio settings of the computer and verify that the audio output is through the speakers.

### No CAC (COMMON ACCESS CARD, SMART CARD READER)

- Check if the USB cables connecting the unit and the computers are properly connected.
- Make sure the CAC port is enabled by holding down the desired channels button until it lights up.

## TECHNICAL SUPPORT

For product inquiries, warranty questions, or technical questions, please contact [info@blackbox.com](mailto:info@blackbox.com).

---

## LIMITED WARRANTY STATEMENT

### A. Extent of limited warranty

Black Box, Inc. warrants to the end-user customers that the Black Box product specified above will be free from defects in materials and workmanship for the duration of 1 year, which duration begins on the date of purchase by the customer. Customer is responsible for maintaining proof of date of purchase.

Black Box limited warranty covers only those defects which arise as a result of normal use of the product, and do not apply to any:

- a. Improper or inadequate maintenance or modifications
- b. Operations outside product specifications
- c. Mechanical abuse and exposure to severe conditions

If Black Box receives, during applicable warranty period, a notice of defect, Black Box will at its discretion replace or repair defective product. If Black Box is unable to replace or repair defective product covered by the Black Box warranty within reasonable period of time, Black Box shall refund the cost of the product.

Black Box shall have no obligation to repair, replace or refund unit until customer returns defective product to Black Box.

Any replacement product could be new or like new, provided that it has functionality at least equal to that of the product being replaced.

Black Box limited warranty is valid in any country where the covered product is distributed by Black Box.

### B. Limitations of warranty

To the extent allowed by local law, neither Black Box nor its third party suppliers make any other warranty or condition of any kind whether expressed or implied with respect to the Black Box product, and specifically disclaim implied warranties or conditions of merchantability, satisfactory quality, and fitness for a particular purpose.

### C. Limitations of liability

To the extent allowed by local law the remedies provided in this warranty statement are the customers sole and exclusive remedies.

To the extent allowed by local law, except for the obligations specifically set forth in this warranty statement, in no event will Black Box or its third party suppliers be liable for direct, indirect, special, incidental, or consequential damages whether based on contract, tort or any other legal theory and whether advised of the possibility of such damages.

### D. Local law

To the extent that this warranty statement is inconsistent with local law, this warranty statement shall be considered modified to be consistent with such law.



## NOTICE

The information contained in this document is subject to change without notice. BlackBox makes no warranty of any kind with regard to this material, including but not limited to, implied warranties of merchant-ability and fitness for particular purpose. Blackbox will not be liable for errors contained herein or for inci-dental or consequential damages in connection with the furnishing, performance or use of this material. No part of this document may be photocopied, reproduced, or translated into another language without prior written consent from Blackbox, Inc.

20180403

Black Box Corporation  
1000 Park Drive  
Lawrence, PA 15055-1018

**Phone: 877-877-2269**

[www.blackbox.com](http://www.blackbox.com)