



## **QNAP Turbo NAS**

# **TES-x85U Series Hardware User Manual**

Thank you for choosing QNAP products! This user manual provides description of the hardware of the Turbo NAS and relevant guideline of certain functions. Please read carefully and strictly adhere to the instructions of the manual.

This user manual is applicable to the following Turbo NAS models: TES-1885U, TES-3085U
-------------------------------------------------------------------------------------------

**NOTE**

- The “Turbo NAS” is hereafter referred to as “NAS”.
- The product you purchased may not support certain functions dedicated to specific models.
- All features, functionality, and other product specifications are subject to change without prior notice or obligation.
- Information presented is subject to change without notice.
- No part of this publication may be reproduced, stored in a retrieval system, or transmitted, in any form or by any means, mechanical, electronic, photocopying, recording, or otherwise, without prior written permission of QNAP Systems, Inc.
- QNAP and the QNAP logo are registered trademarks of QNAP Systems, Inc. Other products and company names mentioned herein may be the trademarks of their respective companies.

## **DISCLAIMER**

In no event shall QNAP Systems, Inc. (QNAP) liability exceed the price paid for the product from direct, indirect, special, incidental, or consequential damages resulting from the use of the product, its accompanying software, or its documentation. QNAP makes no warranty or representation, expressed, implied, or statutory, with respect to its products or the contents or use of this documentation and all accompanying software, and specifically disclaims its quality, performance, merchantability, or fitness for any particular purpose. QNAP reserves the right to revise or update its products, software, or documentation without obligation to notify any individual or entity.

### **Note:**

- Back up your system periodically to avoid any potential data loss. QNAP disclaims any responsibility of all sorts of data loss or recovery.
- Should you return any components of the NAS package for refund or maintenance, make sure they are carefully packed for shipping. Any form of damages due to improper packaging will not be compensated.

## Regulatory Notice



### FCC Class A Notice

The TES-x85U series complies with Part 15 of the FCC Rules. Operation is subject to the following two conditions:

1. This device may not cause harmful interference.
2. This device must accept any interference received, including interference that may cause undesired operation.

Note: This equipment has been tested and found to comply with the limits for a Class A digital device, pursuant to Part 15 of the FCC Rules. These limits are designed to provide reasonable protection against harmful interference when the equipment is operated in a commercial environment. This equipment generates, uses, and can radiate radio frequency energy, and if not installed and used in accordance with the instruction manual, may cause harmful interference to radio communications. Operation of this equipment in a residential area is likely to cause harmful interference, in which case the user will be required to correct the interference at his own expense.

Modifications: Any modifications made to this device that are not approved by QNAP Systems, Inc. may void the authority granted to the user by the FCC to operate this equipment.





The TES-x85U series complies with CE compliance classes A.

#### RESTRICTED ACCESS LOCATION

This equipment must be only located where both of the following apply:

- Only authorized and knowledgeable personnel can access the equipment
- Access to the equipment is restricted through the use of lock and key or other means of security and this access is controlled by those in charge of the location.

### Symbols in this document

 Warning	This icon indicates the instructions must be strictly followed. Failure to do so could result in injury to human body or death.
 Caution	This icon indicates the action may lead to disk clearance or loss OR failure to follow the instructions could result in data damage, disk damage, or product damage.

## Table of Contents

<b>Table of Contents .....</b>	<b>7</b>
<b>Safety Warnings .....</b>	<b>8</b>
<b>Chapter 1. CPU and Memory Specifications .....</b>	<b>9</b>
<b>Chapter 2. Power Button and Reset Button Behavior .....</b>	<b>13</b>
<b>Chapter 3. LED and Alarm Buzzer Specifications .....</b>	<b>15</b>
3.1 LED .....	15
3.2 BEEP ALARM .....	18
<b>Chapter 4. Upgrade Memory on QNAP Turbo NAS (RAM Module Installation) 19</b>	
<b>Chapter 5. Expansion Card Installation .....</b>	<b>23</b>
<b>Chapter 6. Install and Hot-swap Hard Drives .....</b>	<b>26</b>
6.1 HARD DRIVE BAY NUMBERING .....	26
6.2 INSTALL HARD DRIVES .....	28
6.3 RAID RECOVERY - HOT-SWAP HARD DRIVES .....	30
6.4 RAID RECOVERY - ACCIDENTALLY REMOVAL OF HEALTHY HARD DRIVE (QTS) .....	32
<b>Chapter 7. Install Power Supply Unit and Redundant Power Supply Mode ....</b>	<b>34</b>
<b>Technical Support .....</b>	<b>37</b>
<b>GNU GENERAL PUBLIC LICENSE .....</b>	<b>38</b>

## Safety Warnings

1. The NAS can operate normally in temperatures of 0°C–40°C (32°F -104°F) and relative humidity of 5%–95%. Please make sure the environment is well-ventilated.
2. The power cord and devices connected to the NAS must provide correct supply voltage (100W, 90–264V).
3. Do not place the NAS in direct sunlight or near chemicals. Make sure the temperature and humidity of the environment are in optimized level.
4. Unplug the power cord and all connected cables before cleaning. Wipe the NAS with a dry towel. Do not use chemical or aerosol to clean the NAS.
5. Do not place any objects on the NAS for the server's normal operation and to avoid overheat.
6. Use the flat head screws in the product package to lock the hard disks in the NAS when installing hard disks for proper operation.
7. Do not place the NAS near any liquid.
8. Do not place the NAS on any uneven surface to avoid falling off and damage.
9. Make sure the voltage is correct in the location where the NAS is installed. Contact the distributor or the local power supply company for the information.
10. Do not place any object on the power cord.
11. Do not attempt to repair the NAS in any occasions. Improper disassembly of the product may expose the users to electric shock or other risks. For any enquiries, please contact the distributor.
12. The NAS should only be installed in the server room and maintained by the authorized server manager or IT administrator. The server room is locked by key or keycard access and only certified staff is allowed to enter the server room.



### **Warning:**

- Danger of explosion if battery is incorrectly replaced. Replace only with the same or equivalent type recommended by the manufacturer. Dispose of used batteries according to the manufacturer's instructions.
- Do NOT touch the fan inside the system to avoid serious injuries.



## Chapter 1. CPU and Memory Specifications



**Caution:** Any unauthorized modifications performed on QNAP products will result in the warranty being voided. QNAP is not responsible for any form of damage or loss of data caused by such modifications. Unauthorized modifications include, but are not limited to, changes made to the default system firmware, installation of unofficial third party applications, and changes to the hardware performed by unauthorized technicians.

	<b>TES-1885U-D1531-32G</b>	<b>TES-1885U-D1531-64G</b>
<b>CPU</b>	Intel® Xeon® 6-core Processor D-1531 (9M Cache, 2.2 GHz)	Intel® Xeon® 6-core Processor D-1531 (9M Cache, 2.2 GHz)
<b>Memory</b>	32GB Non-ECC DDR4 RAM UDIMM	64GB Non-ECC DDR4 RAM UDIMM
<b>Flash Memory</b>	4GB (USB DOM)	4GB (USB DOM)
<b>CPU Replaceable</b>	No	No
<b>Memory Replaceable</b>	Yes	Yes
<b>Long-DIMM slots</b>	4	4
<b>Hard drive slots</b>	12+6	12+6
<b>PCIe slots</b>	4	4

	<b>TES-1885U-D1531-16GR</b>	<b>TES-1885U-D1531-32GR</b>
<b>CPU</b>	Intel® Xeon® 6-core Processor D-1531 (9M Cache, 2.2 GHz)	Intel® Xeon® 6-core Processor D-1531 (9M Cache, 2.2 GHz)
<b>Memory</b>	16GB ECC DDR4 RAM RDIMM	32GB ECC DDR4 RAM RDIMM
<b>Flash Memory</b>	4GB (USB DOM)	4GB (USB DOM)
<b>CPU Replaceable</b>	No	No
<b>Memory Replaceable</b>	Yes	Yes
<b>Long-DIMM slots</b>	4	4
<b>Hard drive slots</b>	12+6	12+6
<b>PCIe slots</b>	4	4

	<b>TES-1885U-D1531-128GR</b>
<b>CPU</b>	Intel® Xeon® 6-core Processor D-1531 (9M Cache, 2.2 GHz)
<b>Memory</b>	128GB ECC DDR4 RAM RDIMM
<b>Flash Memory</b>	4GB (USB DOM)
<b>CPU Replaceable</b>	No
<b>Memory Replaceable</b>	Yes
<b>Long-DIMM slots</b>	4
<b>Hard drive slots</b>	12+6
<b>PCIe slots</b>	4

	<b>TES-1885U-D1521-8GR</b>	<b>TES-1885U-D1521-16GR</b>
<b>CPU</b>	Intel® Xeon® Processor D-1521, 4-core 2.4 GHz	Intel® Xeon® Processor D-1521, 4-core 2.4 GHz
<b>Memory</b>	8 GB ECC RAM (4 GB RDIMM x 2)	16 GB ECC RAM (8 GB RDIMM x 2)
<b>Flash Memory</b>	4GB DOM	4GB DOM
<b>CPU Replaceable</b>	No	No
<b>Memory Replaceable</b>	Yes	Yes
<b>Long-DIMM slots</b>	4	4
<b>Hard drive slots</b>	12+6	12+6
<b>PCIe slots</b>	4	4

	<b>TES-1885U-D1521-32GR</b>
<b>CPU</b>	Intel® Xeon® Processor D-1521, 4-core 2.4 GHz
<b>Memory</b>	32 GB ECC RAM (8 GB RDIMM x 4)
<b>Flash Memory</b>	4GB DOM
<b>CPU Replaceable</b>	No
<b>Memory Replaceable</b>	Yes

<b>Long-DIMM slots</b>	4
<b>Hard drive slots</b>	12+6
<b>PCIe slots</b>	4

	<b>TES-3085U-D1548-32G</b>	<b>TES-3085U-D1548-64G</b>
<b>CPU</b>	Intel® Xeon® 8-core Processor D-1548 (12M Cache, 2.0 GHz)	Intel® Xeon® 8-core Processor D-1548 (12M Cache, 2.0 GHz)
<b>Memory</b>	32GB Non-ECC DDR4 RAM UDIMM	64GB Non-ECC DDR4 RAM UDIMM
<b>Flash Memory</b>	4GB (USB DOM)	4GB (USB DOM)
<b>CPU Replaceable</b>	No	No
<b>Memory Replaceable</b>	Yes	Yes
<b>Long-DIMM slots</b>	4	4
<b>Hard drive slots</b>	24+6	24+6
<b>PCIe slots</b>	4	4

	<b>TES-3085U-D1548-16GR</b>	<b>TES-3085U-D1548-32GR</b>
<b>CPU</b>	Intel® Xeon® 8-core Processor D-1548 (12M Cache, 2.0 GHz)	Intel® Xeon® 8-core Processor D-1548 (12M Cache, 2.0 GHz)
<b>Memory</b>	16GB ECC DDR4 RAM RDIMM	32GB ECC DDR4 RAM RDIMM
<b>Flash Memory</b>	4GB (USB DOM)	4GB (USB DOM)
<b>CPU Replaceable</b>	No	No
<b>Memory Replaceable</b>	Yes	Yes
<b>Long-DIMM slots</b>	4	4
<b>Hard drive slots</b>	24+6	24+6
<b>PCIe slots</b>	4	4

	<b>TES-3085U-D1548-128GR</b>
<b>CPU</b>	Intel® Xeon® 8-core Processor D-1548 (12M Cache, 2.0 GHz)
<b>Memory</b>	128GB ECC DDR4 RAM RDIMM
<b>Flash Memory</b>	4GB (USB DOM)
<b>CPU Replaceable</b>	No
<b>Memory Replaceable</b>	Yes
<b>Long-DIMM slots</b>	4
<b>Hard drive slots</b>	24+6
<b>PCIe slots</b>	4

	<b>TES-3085U-D1531-16GR</b>	<b>TES-3085U-D1531-32GR</b>
<b>CPU</b>	Intel® Xeon® Processor D-1531, 6-core 2.2 GHz	Intel® Xeon® Processor D-1531, 6-core 2.2 GHz
<b>Memory</b>	16 GB ECC RAM (8 GB RDIMM x 2)	32 GB ECC RAM (8 GB RDIMM x 4)
<b>Flash Memory</b>	4GB DOM	4GB DOM
<b>CPU Replaceable</b>	No	No
<b>Memory Replaceable</b>	Yes	Yes

<b>Long-DIMM slots</b>	4	4
<b>Hard drive slots</b>	24+6	24+6
<b>PCIe slots</b>	4	4

	<b>TES-3085U-D1521-16GR</b>	
<b>CPU</b>	Intel® Xeon® Processor D-1521, 4-core 2.4 GHz	
<b>Memory</b>	16 GB ECC RAM (8 GB RDIMM x 2)	
<b>Flash Memory</b>	4GB DOM	
<b>CPU Replaceable</b>	No	
<b>Memory Replaceable</b>	Yes	
<b>Long-DIMM slots</b>	4	
<b>Hard drive slots</b>	24+6	
<b>PCIe slots</b>	4	

## Chapter 2. Power Button and Reset Button Behavior



- Power button: Press to turn on or turn off.

<b>System</b>	<b>Power button (Turn on)</b>	<b>Power button (Hardware turn off)</b>	<b>Power button (Force turn off)</b>
All models	Press once	1.5 sec	5 sec

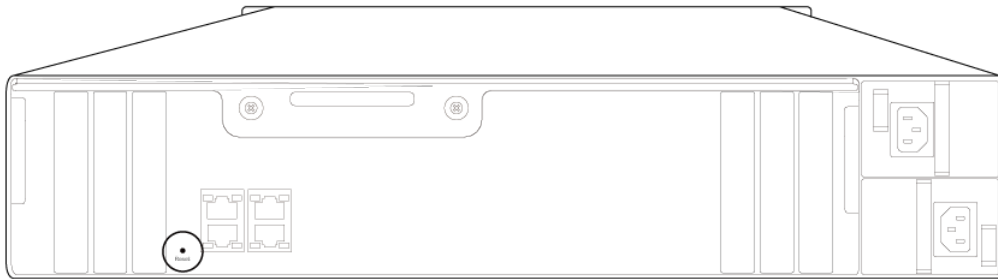

- Reset button: Press to reset the system settings.

System	Basic system reset (1 beep)	Advanced system reset (2 beeps)
All models	3 sec	10 sec

### Basic system reset (3 sec)

Press the reset button for 3 seconds, a beep sound will be heard. The following settings are reset to default:

- System administration password: admin
- TCP/IP configuration: Obtain the IP address settings automatically via DHCP
- TCP/IP configuration: Disable Jumbo Frame
- TCP/IP configuration: If port trunking is enabled (dual LAN models only), the port trunking mode will be reset to "Active Backup (Failover)".
- System Port: 8080 (system service port)
- Security Level: Low (Allow all connections)
- VLAN will be disabled.
- Service binding: All the NAS services run on all available network interfaces.

### Advanced system reset (10 sec)

Press the reset button for 10 seconds; you will hear two beeps at the third and the tenth seconds. The NAS will reset all the system settings to default as it does by web-based system reset in "Control Panel" > "System Settings" > "Backup / Restore" > "Restore to Factory Default" except all the data are reserved. The settings such as the users, user groups, and the network share folders previously created will be cleared. To retrieve the old data after the advanced system reset, create the same network share folders on the NAS and the data will be accessible again.

## Chapter 3. LED and Alarm Buzzer Specifications

### 3.1 LED

The LED indicators of the NAS indicate the system status and information. When the NAS is turned on, check the following items to make sure the system status is normal. Note that the following LED information is applicable only when users have properly installed the hard drive, and connected the NAS to the network and the power supply.

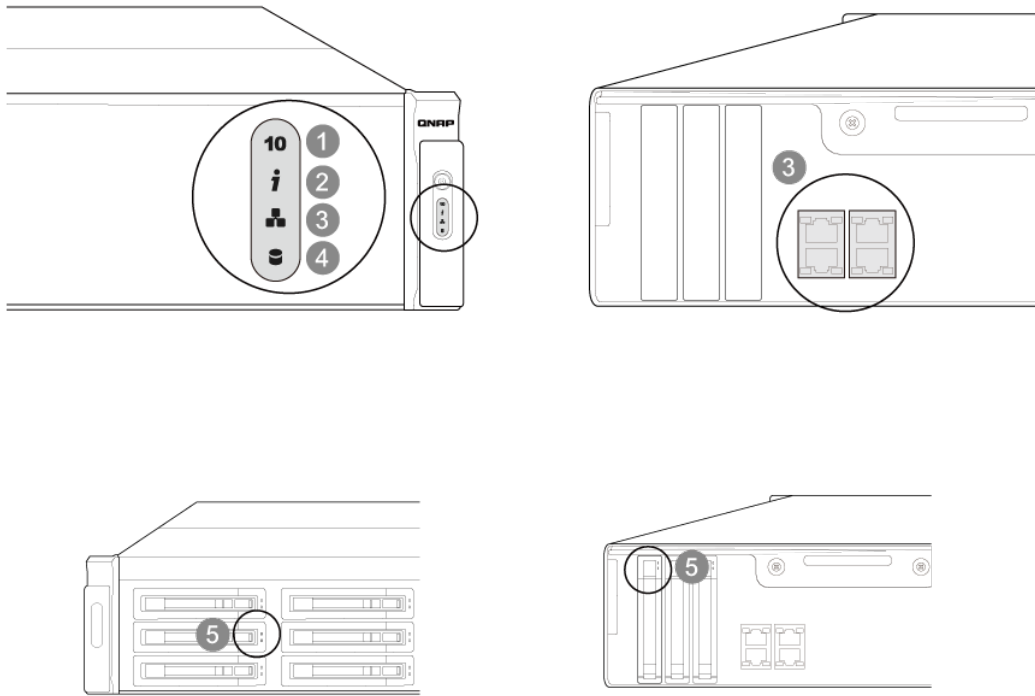

LED	Color	LED Status	Description
10 GbE	Green	Green	The 10GbE network expansion card is installed.
		Off	No 10GbE network expansion card is installed.
System Status	Red/Green	Flashes green and red alternately every 0.5 sec	<ol style="list-style-type: none"> <li>1. The hard drive on the NAS is being formatted.</li> <li>2. The NAS is being initialized.</li> <li>3. The system firmware is being updated.</li> <li>4. RAID rebuilding is in process.</li> <li>5. Online RAID capacity expansion is in process.</li> <li>6. Online RAID level migration is in process.</li> </ol>
		Red	<ol style="list-style-type: none"> <li>1. The hard drive is invalid.</li> <li>2. The disk volume has reached its full capacity.</li> <li>3. The disk volume is going to be full.</li> <li>4. The system fan is out of function.</li> <li>5. An error occurs when accessing (read/write) the disk data.</li> <li>6. A bad sector is detected on the hard drive.</li> <li>7. The NAS is in degraded read-only mode (2 member drives fail in a RAID 5 or RAID 6 configuration, the disk data can still be read).</li> <li>8. Hardware self-test error.</li> </ol>
		Flashes red every 0.5 sec	The NAS is in degraded mode (one member drive fails in RAID 1, RAID 5 or RAID 6 configuration).
		Flashes green every 0.5 sec	<ol style="list-style-type: none"> <li>1. The NAS is starting up.</li> <li>2. The NAS is not configured.</li> <li>3. A hard disk drive is not formatted.</li> </ol>
		Green	The NAS is ready.
		Deep flashes of orange	The NAS is in sleep mode.



		Off	All the hard drives on the NAS are in standby mode.
LAN	Orange	Orange	The disk data is being accessed from the network and a read/write error occurs during the process.
		Flashes orange	The NAS is connected to the network.
Storage Expansion Port Status	Orange	Off	No expansion enclosures are detected.
		Orange	Expansion enclosures are detected.
HDD	Red/ Green	Flashes red	The NAS is being accessed from the network.
		Red	A hard drive read/write error occurs.
		Flashes green	The disk data is being accessed.
		Green	The hard drive can be accessed.

### 3.2 Beep Alarm

The beep alarm can be disabled in "Control Panel" > "System Settings" > "Hardware".

Beep sound	Number of Times	Description
Short beep (0.5 sec)	1	<ol style="list-style-type: none"> <li>1. The NAS is starting up.</li> <li>2. The NAS is being shut down (software shutdown).</li> <li>3. The user presses the reset button to reset the NAS.</li> <li>4. The system firmware has been updated.</li> </ol>
Long beep (1.5 sec)	3, every 5 min	The system fan is out of function.
Long beep (1.5 sec)	2	<ol style="list-style-type: none"> <li>1. The disk volume is going to be full.</li> <li>2. The disk volume has reached its full capacity.</li> <li>3. The hard drives on the NAS are in degraded mode.</li> <li>4. The user starts the hard drive rebuilding process.</li> <li>5. A hard drive is plugged in or out.</li> </ol>
	1	<ol style="list-style-type: none"> <li>1. The NAS is turned off by force shutdown (hardware shutdown).</li> <li>2. The NAS has been turned on and is ready.</li> </ol>

## Chapter 4. Upgrade Memory on QNAP Turbo NAS (RAM Module Installation)



### Warning:

- The following instructions should only be performed by an authorized or trained technician.
- Strictly adhere to the instructions in this section to install RAM modules in NAS. Failure to do so could result in property damage, bodily harm or even death.

The TES-x85U series allows users to upgrade the memory in their QNAP NAS devices. Ensure that the type of RAM is compatible with the NAS before installing. To determine how much memory is currently in the system, log into QES/QTS as administrator and go to “Control Panel” > “System Settings” > “System Status” to open the System Status window. Under System Information, check for System memory or Total memory.

Carefully follow the steps below:

1. Power off the NAS. Wait for device to fully power down.
2. Disconnect power cord(s), network cable(s), and any other cables attached to the device.
3. Before opening the NAS, wear an antistatic wrist strap and connect the crocodile clamp to ground to prevent electrostatic discharge from damaging equipment.
4. Loosen the 2 screws on the back of the NAS located on the handle.

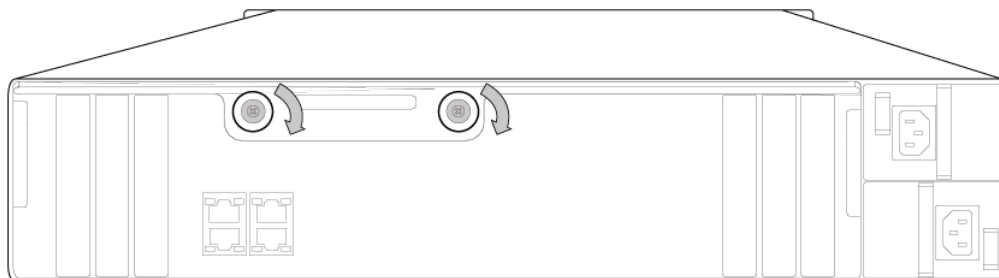

5. Pull the handle outwards to remove the motherboard drawer.

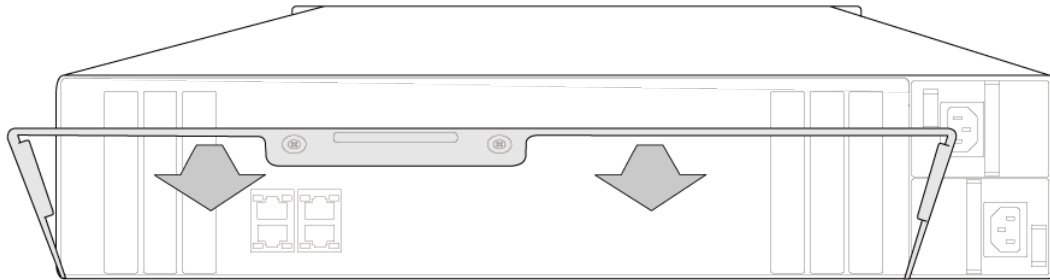

6. Unlock the RAM slot by pressing down on the retention clamps on the sides of the RAM slot. If replacing RAM, remove existing module from socket.

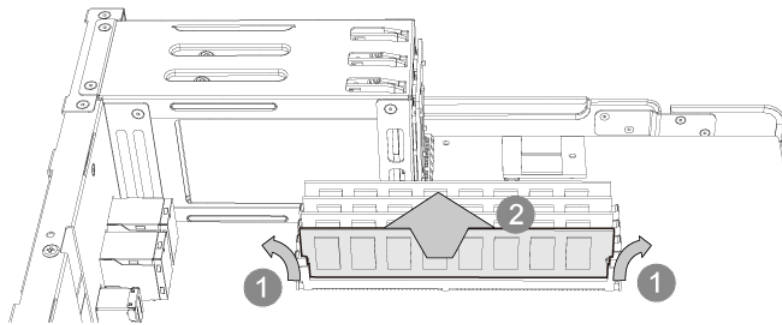

7. Install new RAM:

- i. Grip the new RAM on the edges to avoid touching contacts or circuitry on the module.
- ii. Line up the notch on the RAM to the break in the slot. Ensure that first RAM module is inserted into slot 1 (see below for slot positioning).
- iii. Set the stick into the slot and apply equal pressure onto both ends of the stick until the clamps on the side click and fully lock the RAM in.

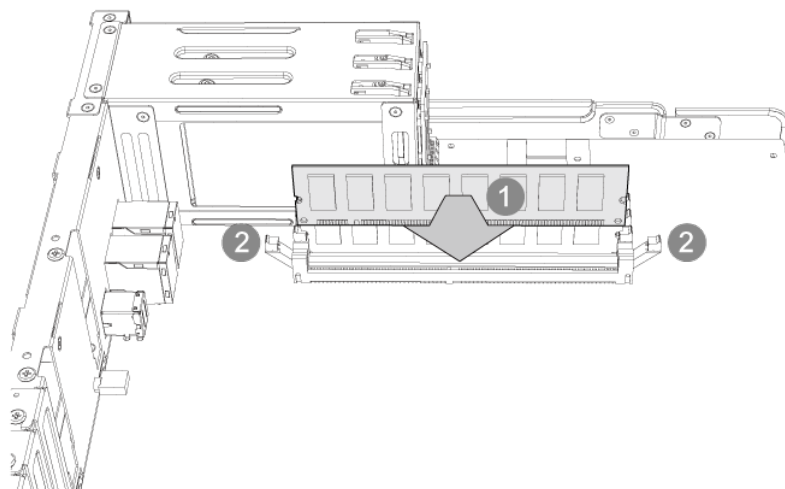
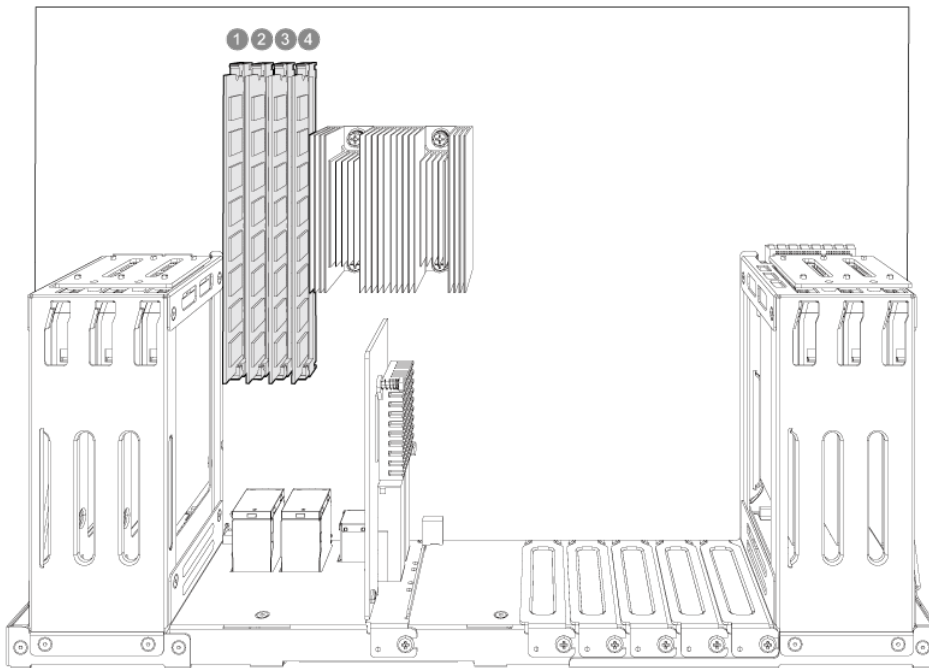

- Slide the motherboard drawer back into the NAS and pull the handle up to close enclosure and insert screws on the handle.

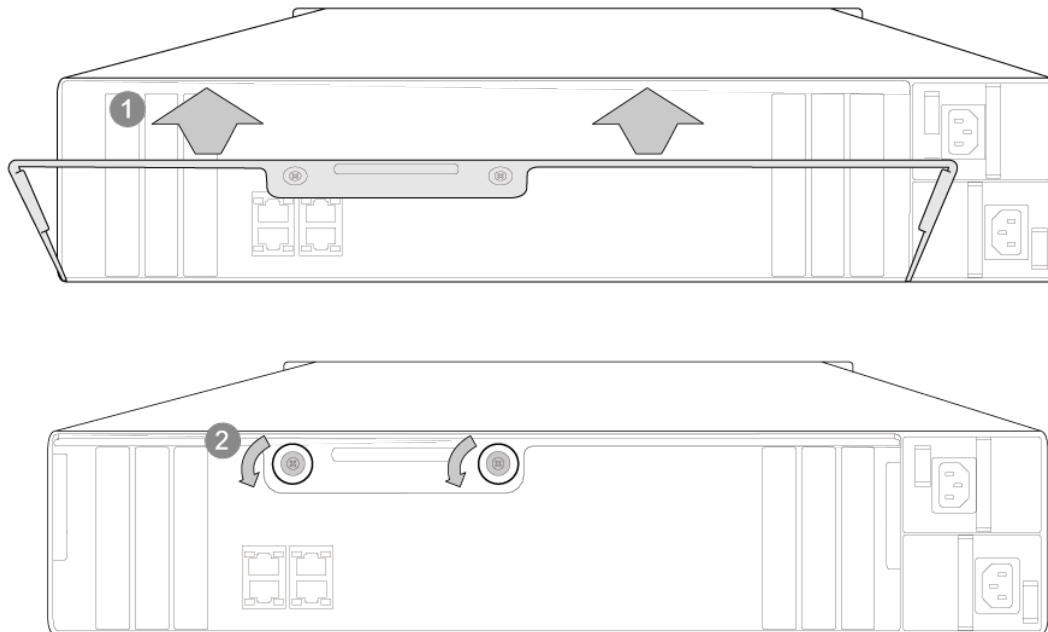

- Reconnect all cables back into the NAS.
- Power on NAS.
- To verify that the memory module is installed correctly and is recognized by the operating system, log into QES/QTS as administrator and go to "Control Panel" > "System Settings" > "System Status" > "System Information" and check for System memory or Total memory.

## Chapter 5. Expansion Card Installation



### Warning:

- The following instructions should only be performed by an authorized or trained technician.
- Strictly adhere to the instructions in this section to install PCIe add-in card(s) in NAS. Failure to do so could result in property damage, bodily harm or even death.

The TES-x85U series provides 4 low-profile PCIe expansion slots so that users can add functionality to their NAS. Refer to the compatibility list at <http://qnap.com/compatibility>.

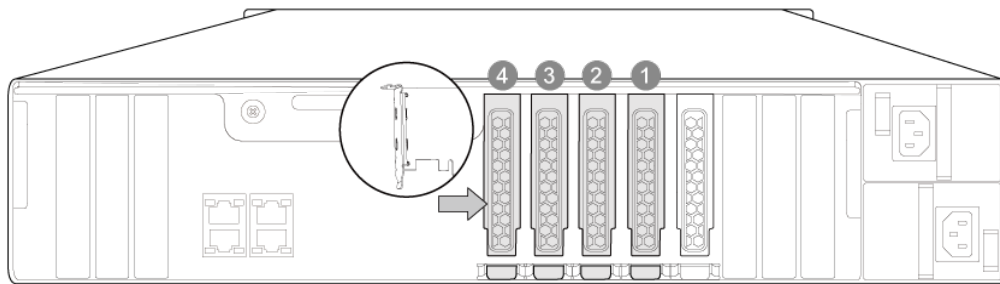

Follow the steps below to install add-in card:

1. Power off the NAS. Wait for device to fully power down.
2. Disconnect power cord(s), network cable(s), and any other cables attached to the device.
3. Before opening the NAS, wear an antistatic wrist strap and connect the crocodile clamp to ground to prevent electrostatic discharge from damaging equipment.
4. Loosen the 2 screws on the back of the NAS located on the handle.

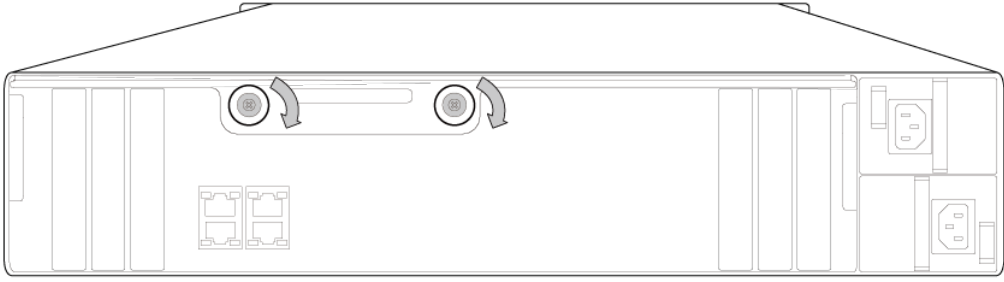

5. Pull the handle outwards to remove the motherboard drawer.

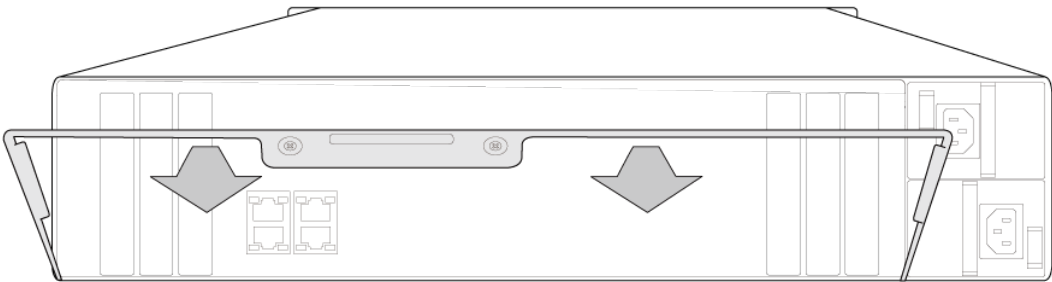

6. Remove screw from the expansion slot cover and detach cover.

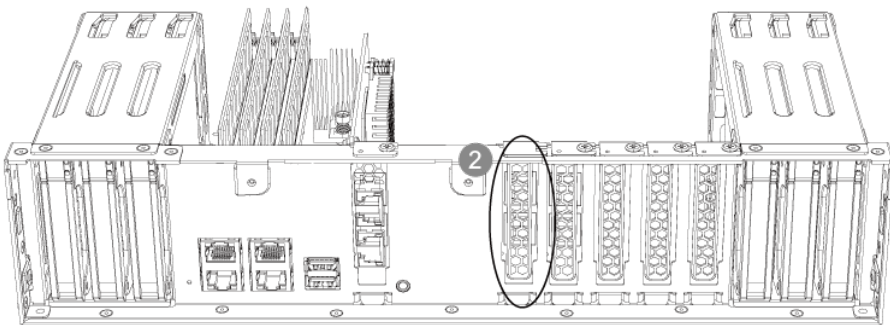
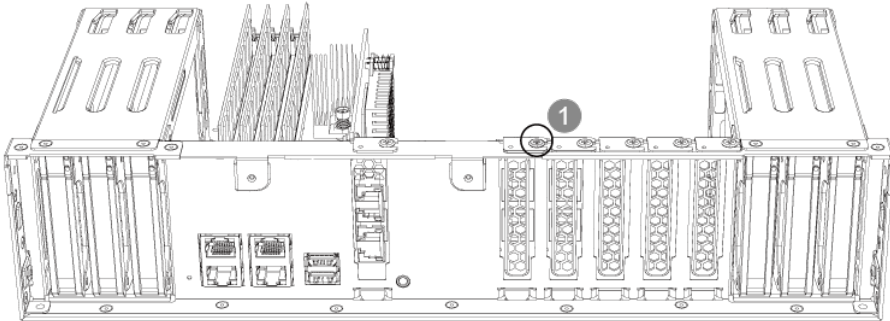



7. Line up the notch on the expansion card to the break in the PCIe slot. Fully insert the expansion card to the expansion slot. Fasten screw to lock in card.

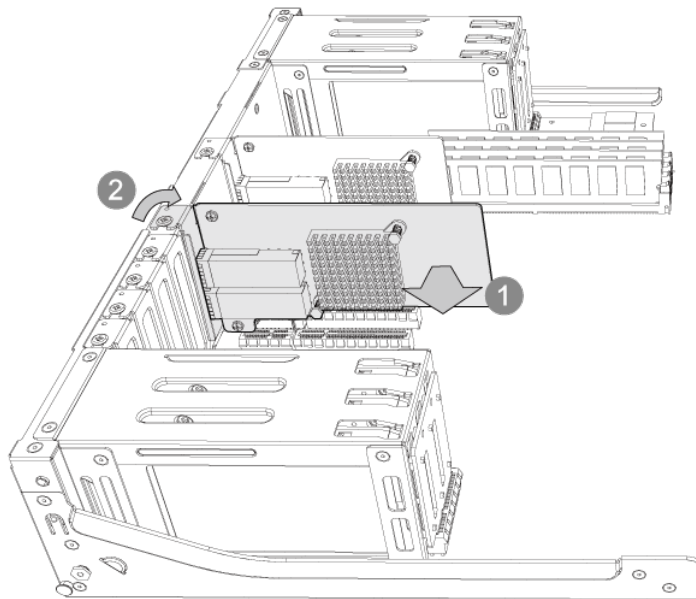

8. Slide the motherboard drawer back into the NAS and pull the handle up to close enclosure and insert screws on the handle.

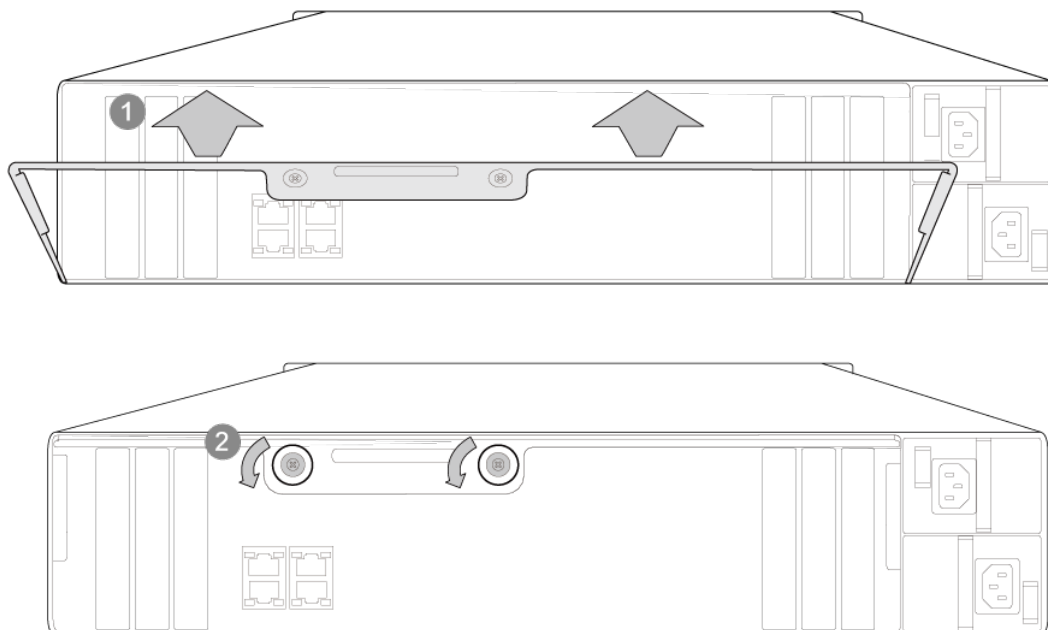

9. Reconnect all cables back into the NAS.
10. Power on NAS.

## Chapter 6. Install and Hot-swap Hard Drives

The TES-x85U series is compatible with 2.5-inch/3.5-inch SAS and SATA hard drives. For hard drive compatibility list, go to <http://www.qnap.com/compatibility>.



### Caution:

- QNAP is not responsible for product damage/malfunction or data loss due to misuse or improper installation of hard disks.
- Note when a hard drive is installed in a QNAP NAS for the first time, the hard drive will be automatically formatted and all the data on disk will be cleared.
- For information on QTS NAS migration, go to docs.qnap.com and check "Migrating from Old NAS" section.

### 6.1 Hard Drive Bay Numbering

Identify the hard drive position in the diagram below.

1. TES-1885U (front) bay numbering:

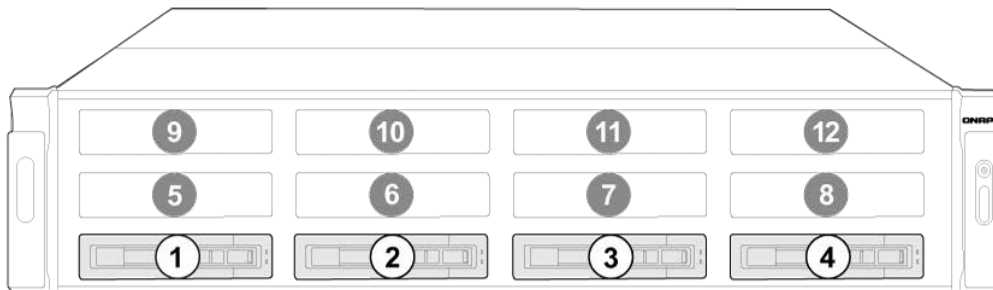

2. TES-1885U (rear) bay numbering:

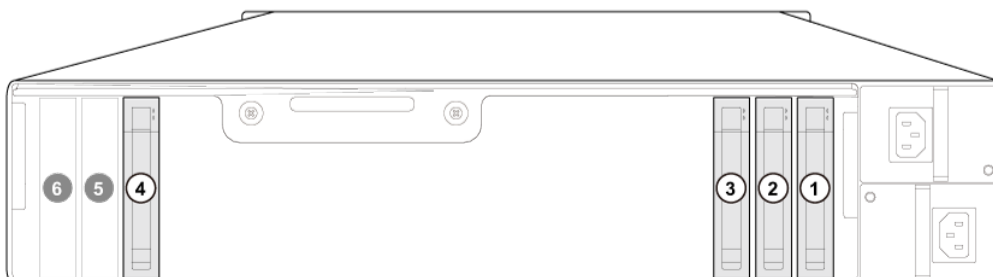

	TES-1885U	
	Front	Rear
<b>Supports 3.5-inch SAS/SATA Hard Drives</b>	Yes	No
<b>Supports 2.5-inch SAS/SATA Hard Drives</b>	Yes	No
<b>Supports 2.5-inch SSD</b>	Yes	Yes
<b>Supports Hot-swapping Hard Drives (RAID 1 or above)</b>	Yes	Yes

3. TES-3085U (front) bay numbering:

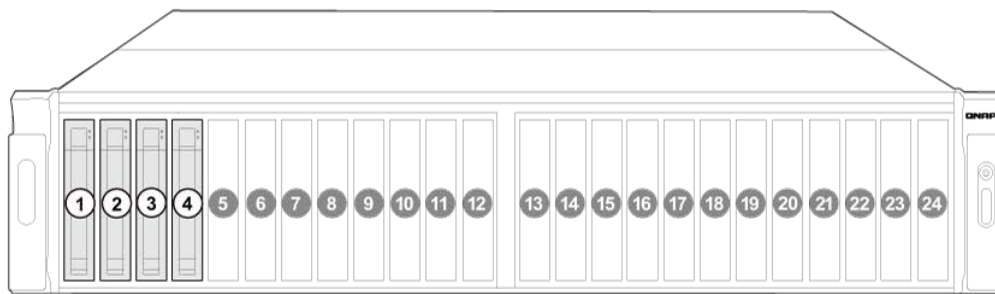

4. TES-3085U (rear) bay numbering:

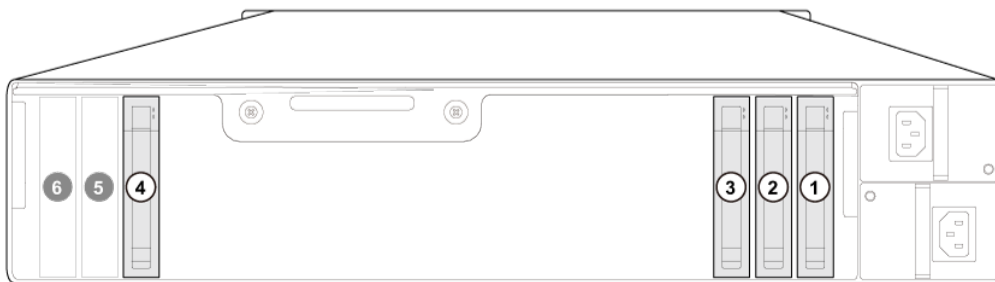

The TES-x85U series uses hard drive bays #1-4 on the front or the back of the unit to store the QES operating system. The user will have the option to select the front or back drives for the operating system during QES quick setup. The QTS operation system is stored across all drive members in the NAS.

Note: TES-x85U series supports either the QES or QTS operating system.

	TES-3085U	
	Front	Rear
<b>Supports 3.5-inch SAS/SATA Hard Drives</b>	No	No
<b>Supports 2.5-inch SAS/SATA Hard Drives</b>	Yes	No
<b>Supports 2.5-inch SSD</b>	Yes	Yes
<b>Supports Hot-swapping Hard Drives (RAID 1 or above)</b>	Yes	Yes

## 6.2 Install Hard Drives

To install hard drives in NAS, follow the steps below:

1. Unlock drive tray and remove from enclosure.

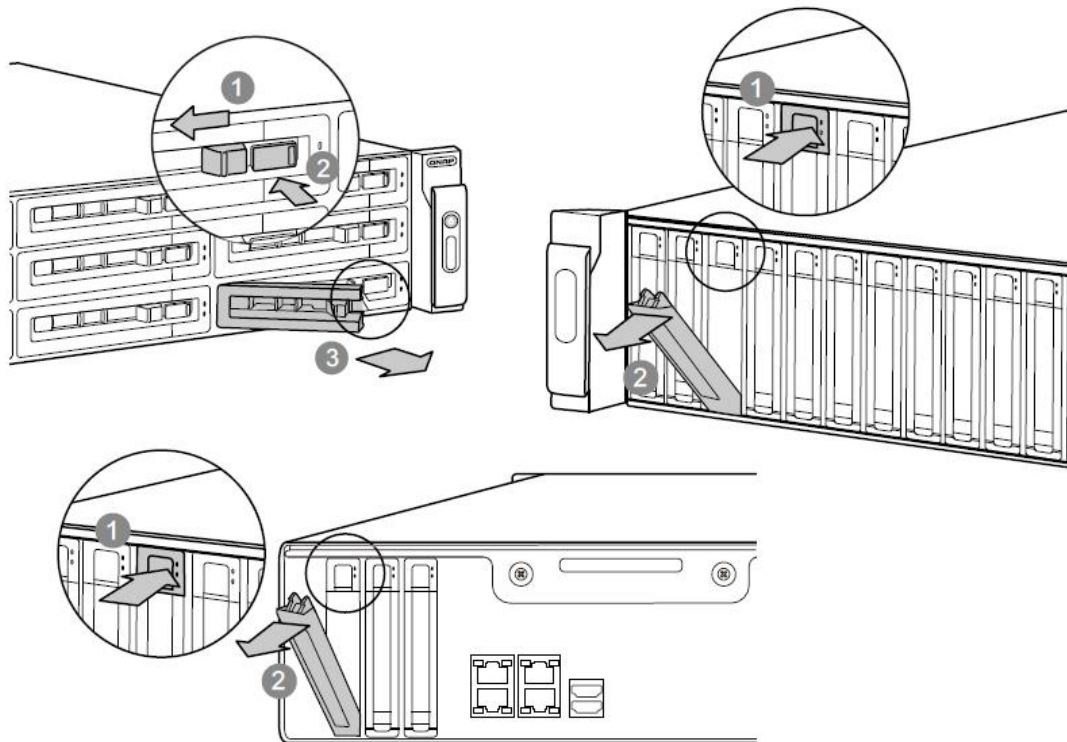

2. Install a 3.5" or 2.5" disk drive to the tray.

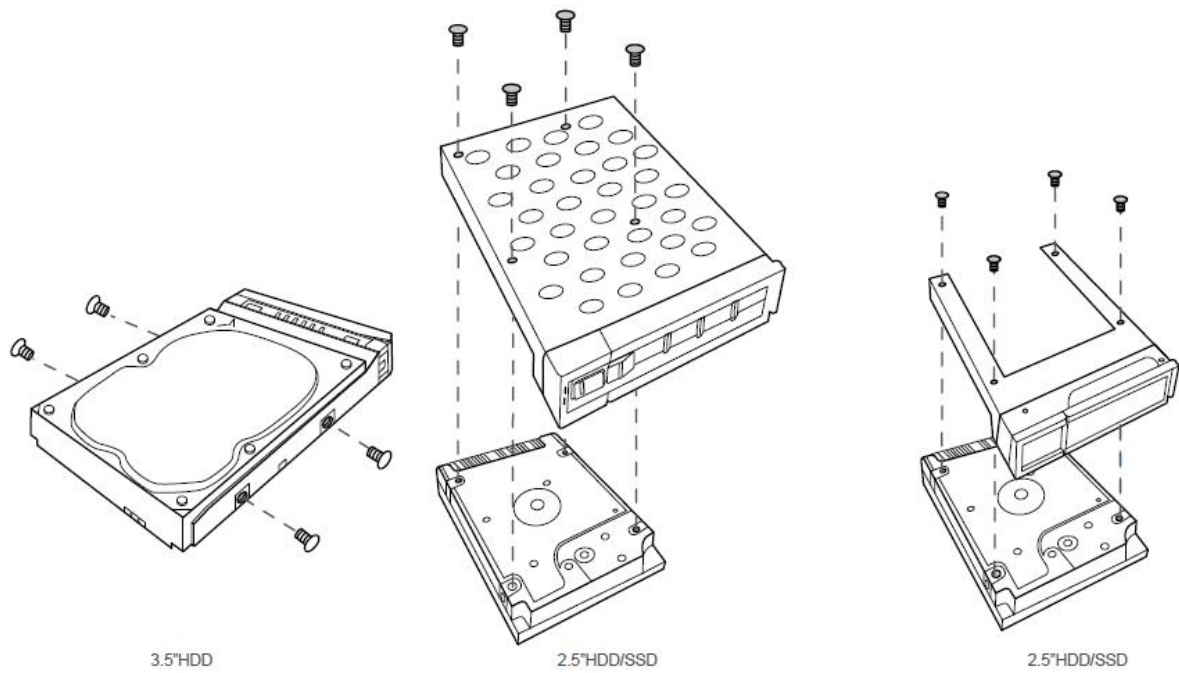

3. Insert the drive tray into the NAS, close and lock the latch.

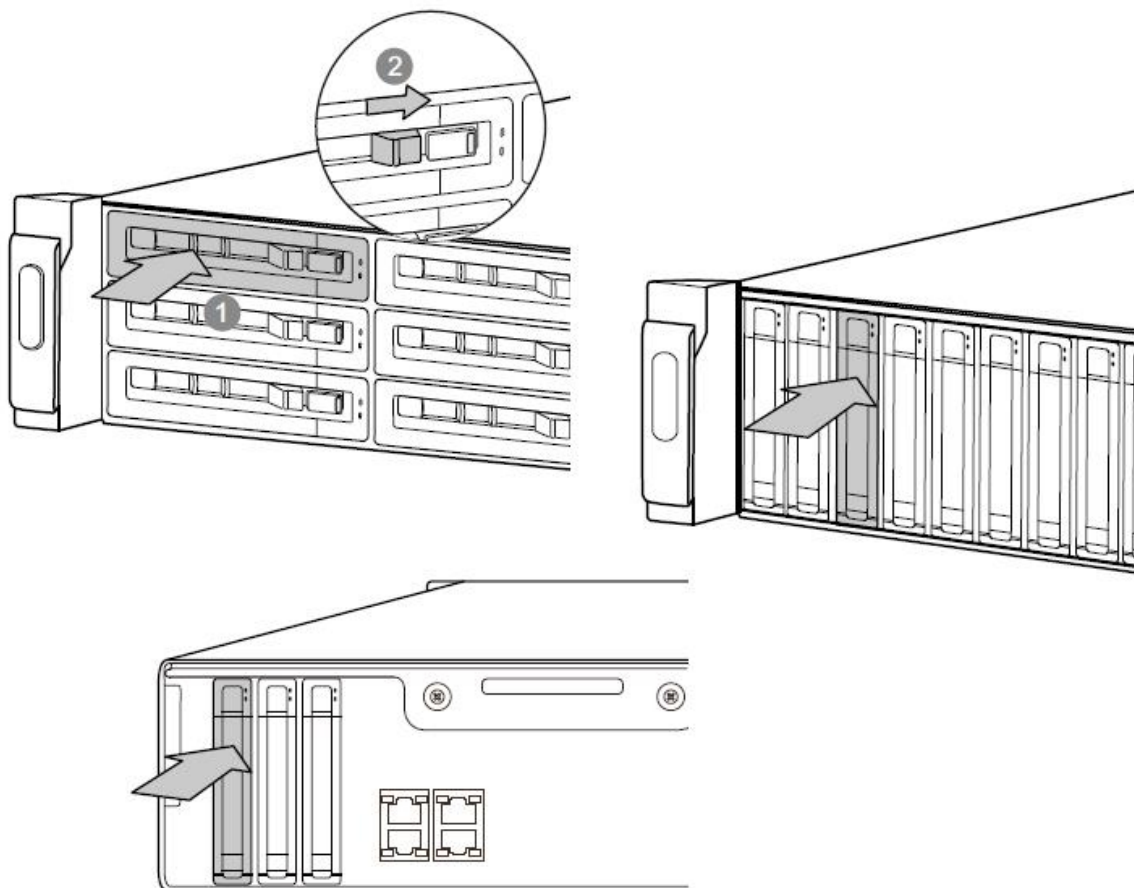

4. To verify that the hard drive has been correctly installed and recognized by the operating system, log into QES/QTS as administrator and go to "Storage Manager" > "Storage" > "Disks" or "Disks/VJOB" and confirm the disk is in the System Component or NAS Host section.

### **6.3 RAID Recovery - Hot-Swap Hard Drives**

The TES-x85U series supports hot-swapping hard drives. When one drive fails in RAID 1/5, up to two drives fail in RAID 6/RAID 10\*/Triple Mirror\*\*, or up to three drives fail in RAID-TP\*\*, replacing failed drives with a healthy ones will automatically trigger QES/QTS to rebuild the RAID. Follow the steps below to hot-swap hard drives when drive failures occur in a RAID configuration. See section 6.2 for detailed instructions on how to install a new drive.

\* One drive each in the RAID 1 pair

\*\* QES only

Follow instructions below for hot-swapping:

1. Log into QES/QTS as administrator and check the storage pool status in "Storage Manager" > "Storage" > "Storage Space". There will be a list of all available storage pools.
2. If one drive fails in RAID 1/5, up to two drives fail in RAID 6/RAID 10\*/Triple Mirror\*\*, or up to three drives fail in RAID-TP\*\*, the storage pool status will be labeled as "Degraded" and the Volume/RAID group status should be labeled as "Warning".
3. Go to "Storage Manager" > "Storage" > "Disks" or "Disks/VJBOD" to determine which disk needs to be replaced.
4. Take out bad drive from NAS enclosure and remove hard drive from tray.
5. Install replacement hard drive onto tray.

Note: the capacity of the new drive must be equal to or greater than the capacity of the old drive.

7. Insert tray with hard drive installed into NAS.

Important: Wait for two beeps after removing the faulty hard drive before inserting replacement drive into NAS. The NAS should also beep twice after replacement hard drive is installed.

8. The volume should automatically rebuild. Go to "Storage Manager" > "Storage" > "Storage Space" to confirm.

## 6.4 RAID Recovery - Accidentally Removal of Healthy Hard Drive (QTS)

The TES-x85U series supports RAID recovery when a healthy drive is unexpectedly removed from a RAID 1/5/6 during hot-swapping or RAID 0/JBOD configuration in QTS. Note that RAID 10 does not support this feature.

When a healthy drive is unexpectedly removed from a RAID group, the status of the RAID will change to "Not active". To recover from an "Not active" status:

1. Re-insert all hard drives back into the NAS in its original order. This includes any bad drive(s) that will need to be replaced after recovery.
2. Log into QTS as administrator and go to "Storage Manager" > "Storage" > "Storage Space".
3. Double click on the affected Storage Pool to open the Storage Pool Management window.
4. In the "Storage Pool Management" window, click on the "Manage" button and select "Recover".

The process should take about 60 seconds for QTS to complete. When recovery is completed, the RAID group should be restored to its initial status.

See chart below for RAID status during this process.

	<b>Initial Status</b>	<b>Status After Healthy Drive is Removed</b>	<b>Status After Drive is Re-Inserted and Storage Pool is Recovered</b>
<b>RAID 0/JBOD</b>	Ready	Not active	Ready
<b>RAID 1/5/6</b>	Ready	Degraded	Rebuilding
<b>RAID 1/5/6</b>	Degraded	Not active	Degraded



The chart below describes the events of an error when using RAID 5.

	<b>RAID 5 (Minimum 3 Disks)</b>	
	<b>QTS</b>	<b>Standard</b>
<b>One drive fails</b>	Degraded mode (may still read and write).	Degraded mode (may still read and write).
<b>One drive fails and there are bad sectors found in the other drive(s)</b>	Read only protect mode (for immediate data backup & hard drive replacement).	RAID crash.
<b>2 hard drives fail</b>	RAID crash.	RAID crash.

The chart below describes the events of an error when using RAID 6.

	<b>RAID 6 (Minimum 4 Disks)</b>	
	<b>QTS</b>	<b>Standard</b>
<b>One or two drives drive fail</b>	Degraded mode. (may still read and write).	Degraded mode. (may still read and write).
<b>Two drives fail and there are bad sectors found in the other drive(s)</b>	Read only protect mode (for immediate data backup & hard drive replacement).	RAID crash.
<b>3 hard drives fail</b>	RAID crash.	RAID crash.

## Chapter 7. Install Power Supply Unit and Redundant Power Supply Mode

**Note:** The following instructions should only be performed by an authorized or trained technician.

### 7.1 Replace Power Supply Unit

To replace a failed power supply unit on the TES-x85U series, follow the steps below.

1. Power off the NAS. Wait for device to fully power down.
2. Disconnect power cord(s), network cable(s), and any other cables attached to the device.
3. Firmly press and hold the orange button on back of PSU towards the black handle. Pull out power supply by pulling black handle.

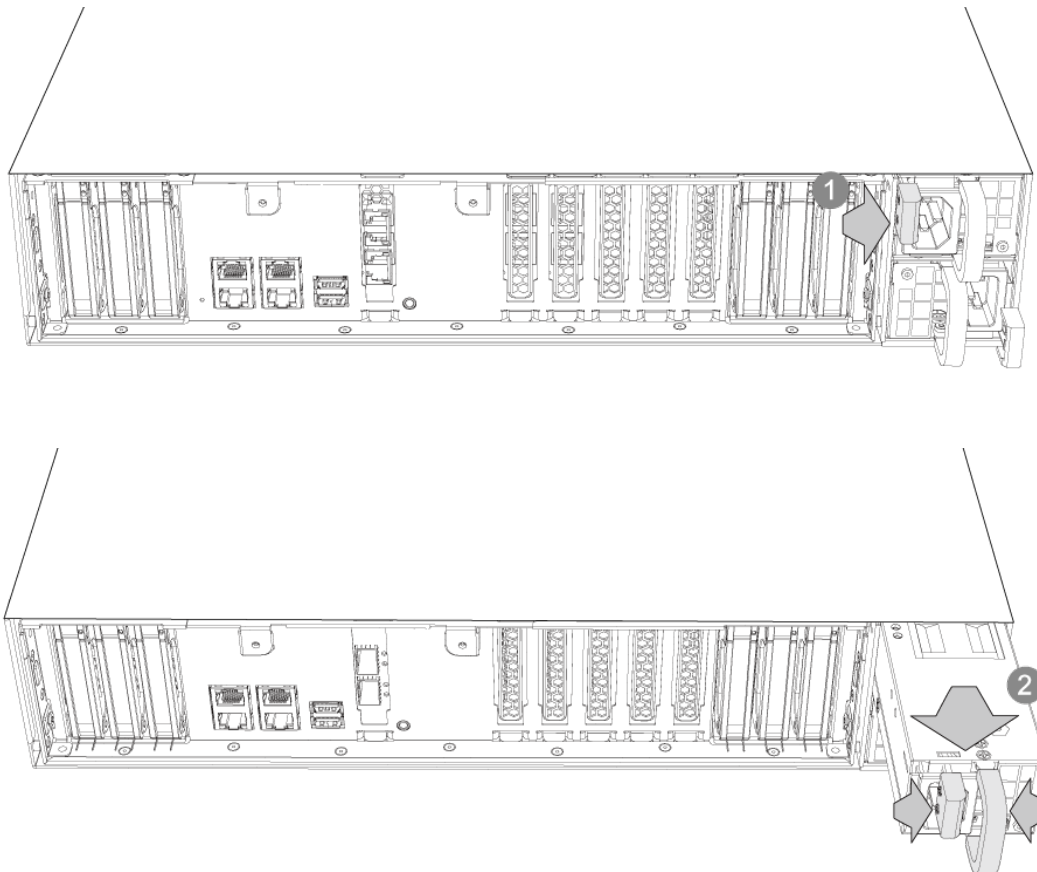

4. Insert new power supply into NAS.

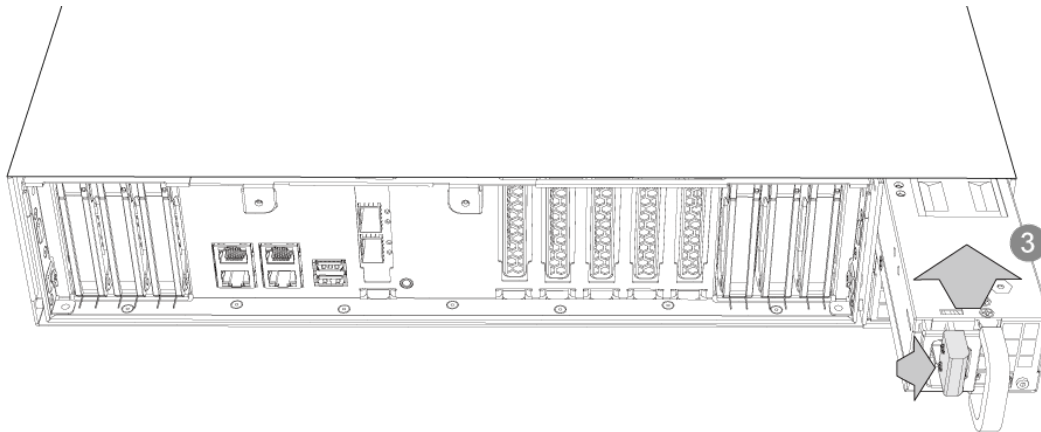

5. Connect the power adaptor and cables to the NAS.

6. Power on NAS.

## 7.2 Redundant Power Supply Mode

If two power supply units (PSU) have been installed on the NAS, both PSUs will supply power to the NAS. Redundant Power Supply Mode is a feature that will alert users of a PSU failure or power interruption. The NAS will beep and log an error message in the “System Logs”. Redundant Power Supply Mode can be enabled in QES/QTS under “Control Panel” > “System Settings” > “Hardware” > “General” > “Enable Redundant Power Supply Mode”. It is not recommended for users to enable this feature for only one PSU. This function is disabled by default.

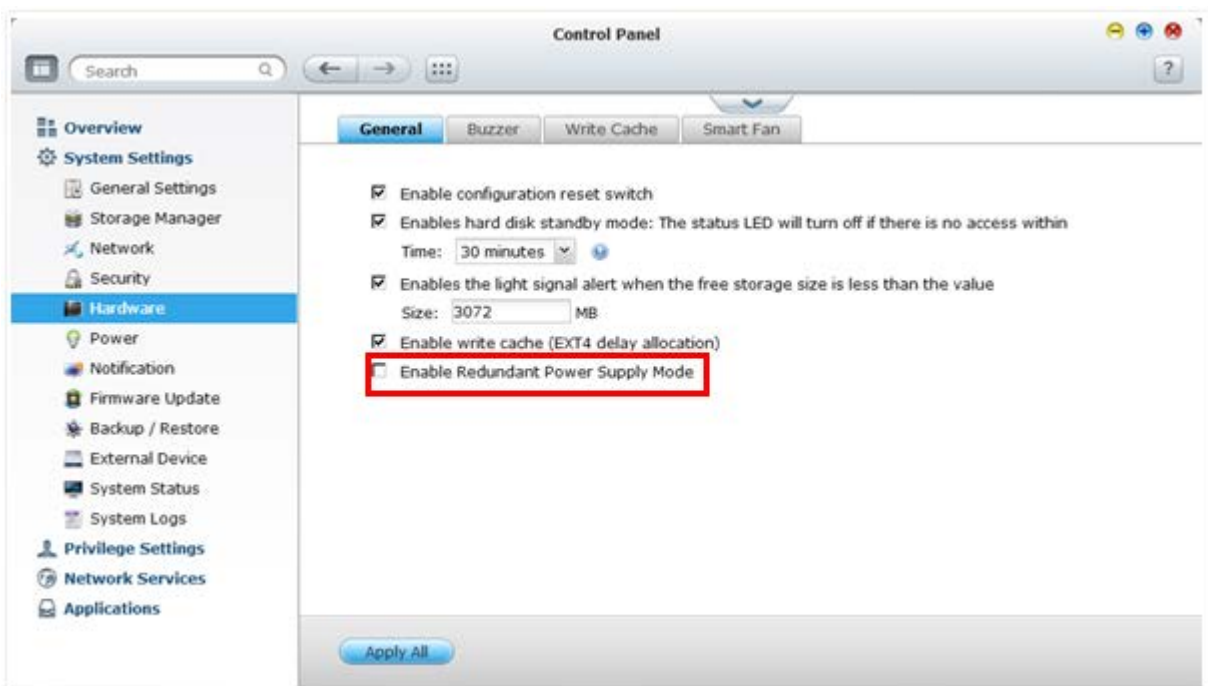

### **WARNING: RISK OF ELECTRIC SHOCK**

The connectors on the back panel (bracketed parts below) contain high voltage. Do NOT touch these parts to avoid the risk of electric shock to the maintenance operator.



## Technical Support

QNAP provides dedicated online support and customer service via instant messenger.

Online Support: <http://www.qnap.com>

Forum: <http://forum.qnap.com>

### **Technical Support in the USA and Canada:**

Online Support: [helpdesk.qnap.com](http://helpdesk.qnap.com)

TEL: +1-909-595-2782 #3

Address: 168 University Parkway, Pomona CA 91768

Service Hours: 06:00-18:00 (GMT-8 08:00 Pacific Time, Monday to Friday)

# GNU GENERAL PUBLIC LICENSE

Version 3, 29 June 2007

Copyright © 2007 Free Software Foundation, Inc. <<http://fsf.org/>>

Everyone is permitted to copy and distribute verbatim copies of this license document, but changing it is not allowed.

## Preamble

The GNU General Public License is a free, copyleft license for software and other kinds of works.

The licenses for most software and other practical works are designed to take away your freedom to share and change the works. By contrast, the GNU General Public License is intended to guarantee your freedom to share and change all versions of a program--to make sure it remains free software for all its users. We, the Free Software Foundation, use the GNU General Public License for most of our software; it applies also to any other work released this way by its authors. You can apply it to your programs, too.

When we speak of free software, we are referring to freedom, not price. Our General Public Licenses are designed to make sure that you have the freedom to distribute copies of free software (and charge for them if you wish), that you receive source code or can get it if you want it, that you can change the software or use pieces of it in new free programs, and that you know you can do these things.

To protect your rights, we need to prevent others from denying you these rights or asking you to surrender the rights. Therefore, you have certain responsibilities if you distribute copies of the software, or if you modify it: responsibilities to respect the freedom of others.

For example, if you distribute copies of such a program, whether gratis or for a fee, you must pass on to the recipients the same freedoms that you received. You must make sure that they, too, receive or can get the source code. And you must show them these terms so they know their rights.

Developers that use the GNU GPL protect your rights with two steps: (1) assert copyright on the software, and (2) offer you this License giving you legal permission to copy, distribute and/or modify it.

For the developers' and authors' protection, the GPL clearly explains that there is no warranty for this free software. For both users' and authors' sake, the GPL requires that modified versions be marked as changed, so that their problems will not be attributed erroneously to authors of previous versions.

Some devices are designed to deny users access to install or run modified versions of the software inside them, although the manufacturer can do so. This is fundamentally incompatible with the aim of protecting users' freedom to change the software. The systematic pattern of such abuse occurs in the area of products for individuals to use, which is precisely where it is most unacceptable. Therefore, we have designed this version of the GPL to prohibit the practice for those products. If such problems arise substantially in other domains, we stand ready to extend this provision to those domains in future versions of the GPL, as needed to protect the freedom of users.

Finally, every program is threatened constantly by software patents. States should not allow patents to restrict development and use of software on general-purpose computers, but in those that do, we wish to avoid the special danger that patents applied to a free program could make it effectively proprietary. To prevent this, the GPL assures that patents cannot be used to render the program non-free.

The precise terms and conditions for copying, distribution and modification follow.

## TERMS AND CONDITIONS

### 0. Definitions.

"This License" refers to version 3 of the GNU General Public License.

"Copyright" also means copyright-like laws that apply to other kinds of works, such as semiconductor masks.

"The Program" refers to any copyrightable work licensed under this License. Each licensee is addressed as "you". "Licensees" and "recipients" may be individuals or organizations.

To "modify" a work means to copy from or adapt all or part of the work in a fashion requiring copyright permission, other than the making of an exact copy. The resulting work is called a "modified version" of the earlier work or a work "based on" the earlier work.

A "covered work" means either the unmodified Program or a work based on the Program.

To “propagate” a work means to do anything with it that, without permission, would make you directly or secondarily liable for infringement under applicable copyright law, except executing it on a computer or modifying a private copy. Propagation includes copying, distribution (with or without modification), making available to the public, and in some countries other activities as well.

To “convey” a work means any kind of propagation that enables other parties to make or receive copies. Mere interaction with a user through a computer network, with no transfer of a copy, is not conveying.

An interactive user interface displays “Appropriate Legal Notices” to the extent that it includes a convenient and prominently visible feature that (1) displays an appropriate copyright notice, and (2) tells the user that there is no warranty for the work (except to the extent that warranties are provided), that licensees may convey the work under this License, and how to view a copy of this License. If the interface presents a list of user commands or options, such as a menu, a prominent item in the list meets this criterion.

#### 1. Source Code.

The “source code” for a work means the preferred form of the work for making modifications to it. “Object code” means any non-source form of a work.

A “Standard Interface” means an interface that either is an official standard defined by a recognized standards body, or, in the case of interfaces specified for a particular programming language, one that is widely used among developers working in that language.

The “System Libraries” of an executable work include anything, other than the work as a whole, that (a) is included in the normal form of packaging a Major Component, but which is not part of that Major Component, and (b) serves only to enable use of the work with that Major Component, or to implement a Standard Interface for which an implementation is available to the public in source code form. A “Major Component”, in this context, means a major essential component (kernel, window system, and so on) of the specific operating system (if any) on which the executable work runs, or a compiler used to produce the work, or an object code interpreter used to run it.

The “Corresponding Source” for a work in object code form means all the source code needed to generate, install, and (for an executable work) run the object code and to modify



the work, including scripts to control those activities. However, it does not include the work's System Libraries, or general-purpose tools or generally available free programs which are used unmodified in performing those activities but which are not part of the work. For example, Corresponding Source includes interface definition files associated with source files for the work, and the source code for shared libraries and dynamically linked subprograms that the work is specifically designed to require, such as by intimate data communication or control flow between those subprograms and other parts of the work.

The Corresponding Source need not include anything that users can regenerate automatically from other parts of the Corresponding Source.

The Corresponding Source for a work in source code form is that same work.

## 2. Basic Permissions.

All rights granted under this License are granted for the term of copyright on the Program, and are irrevocable provided the stated conditions are met. This License explicitly affirms your unlimited permission to run the unmodified Program. The output from running a covered work is covered by this License only if the output, given its content, constitutes a covered work. This License acknowledges your rights of fair use or other equivalent, as provided by copyright law.

You may make, run and propagate covered works that you do not convey, without conditions so long as your license otherwise remains in force. You may convey covered works to others for the sole purpose of having them make modifications exclusively for you, or provide you with facilities for running those works, provided that you comply with the terms of this License in conveying all material for which you do not control copyright. Those thus making or running the covered works for you must do so exclusively on your behalf, under your direction and control, on terms that prohibit them from making any copies of your copyrighted material outside their relationship with you.

Conveying under any other circumstances is permitted solely under the conditions stated below. Sublicensing is not allowed; section 10 makes it unnecessary.

## 3. Protecting Users' Legal Rights From Anti-Circumvention Law.

No covered work shall be deemed part of an effective technological measure under any applicable law fulfilling obligations under article 11 of the WIPO copyright treaty adopted on 20 December 1996, or similar laws prohibiting or restricting circumvention of such measures.

When you convey a covered work, you waive any legal power to forbid circumvention of technological measures to the extent such circumvention is effected by exercising rights under this License with respect to the covered work, and you disclaim any intention to limit operation or modification of the work as a means of enforcing, against the work's users, your or third parties' legal rights to forbid circumvention of technological measures.

#### 4. Conveying Verbatim Copies.

You may convey verbatim copies of the Program's source code as you receive it, in any medium, provided that you conspicuously and appropriately publish on each copy an appropriate copyright notice; keep intact all notices stating that this License and any non-permissive terms added in accord with section 7 apply to the code; keep intact all notices of the absence of any warranty; and give all recipients a copy of this License along with the Program.

You may charge any price or no price for each copy that you convey, and you may offer support or warranty protection for a fee.

#### 5. Conveying Modified Source Versions.

You may convey a work based on the Program, or the modifications to produce it from the Program, in the form of source code under the terms of section 4, provided that you also meet all of these conditions:

- a) The work must carry prominent notices stating that you modified it, and giving a relevant date.
- b) The work must carry prominent notices stating that it is released under this License and any conditions added under section 7. This requirement modifies the requirement in section 4 to "keep intact all notices".
- c) You must license the entire work, as a whole, under this License to anyone who comes into possession of a copy. This License will therefore apply, along with any applicable section 7 additional terms, to the whole of the work, and all its parts, regardless of how they are packaged. This License gives no permission to license the work in any other way, but it does not invalidate such permission if you have separately received it.
- d) If the work has interactive user interfaces, each must display Appropriate Legal Notices; however, if the Program has interactive interfaces that do not display Appropriate Legal Notices, your work need not make them do so.

A compilation of a covered work with other separate and independent works, which are not by their nature extensions of the covered work, and which are not combined with it such as

to form a larger program, in or on a volume of a storage or distribution medium, is called an “aggregate” if the compilation and its resulting copyright are not used to limit the access or legal rights of the compilation's users beyond what the individual works permit. Inclusion of a covered work in an aggregate does not cause this License to apply to the other parts of the aggregate.

#### 6. Conveying Non-Source Forms.

You may convey a covered work in object code form under the terms of sections 4 and 5, provided that you also convey the machine-readable Corresponding Source under the terms of this License, in one of these ways:

a) Convey the object code in, or embodied in, a physical product (including a physical distribution medium), accompanied by the Corresponding Source fixed on a durable physical medium customarily used for software interchange.

b) Convey the object code in, or embodied in, a physical product (including a physical distribution medium), accompanied by a written offer, valid for at least three years and valid for as long as you offer spare parts or customer support for that product model, to give anyone who possesses the object code either (1) a copy of the Corresponding Source for all the software in the product that is covered by this License, on a durable physical medium customarily used for software interchange, for a price no more than your reasonable cost of physically performing this conveying of source, or (2) access to copy the Corresponding Source from a network server at no charge.

c) Convey individual copies of the object code with a copy of the written offer to provide the Corresponding Source. This alternative is allowed only occasionally and noncommercially, and only if you received the object code with such an offer, in accord with subsection 6b.

d) Convey the object code by offering access from a designated place (gratis or for a charge), and offer equivalent access to the Corresponding Source in the same way through the same place at no further charge. You need not require recipients to copy the Corresponding Source along with the object code. If the place to copy the object code is a network server, the Corresponding Source may be on a different server (operated by you or a third party) that supports equivalent copying facilities, provided you maintain clear directions next to the object code saying where to find the Corresponding Source.

Regardless of what server hosts the Corresponding Source, you remain obligated to ensure that it is available for as long as needed to satisfy these requirements.

e) Convey the object code using peer-to-peer transmission, provided you inform other peers where the object code and Corresponding Source of the work are being offered to the general public at no charge under subsection 6d.

A separable portion of the object code, whose source code is excluded from the

Corresponding Source as a System Library, need not be included in conveying the object code work.

A "User Product" is either (1) a "consumer product", which means any tangible personal property which is normally used for personal, family, or household purposes, or (2) anything designed or sold for incorporation into a dwelling. In determining whether a product is a consumer product, doubtful cases shall be resolved in favor of coverage. For a particular product received by a particular user, "normally used" refers to a typical or common use of that class of product, regardless of the status of the particular user or of the way in which the particular user actually uses, or expects or is expected to use, the product. A product is a consumer product regardless of whether the product has substantial commercial, industrial or non-consumer uses, unless such uses represent the only significant mode of use of the product.

"Installation Information" for a User Product means any methods, procedures, authorization keys, or other information required to install and execute modified versions of a covered work in that User Product from a modified version of its Corresponding Source. The information must suffice to ensure that the continued functioning of the modified object code is in no case prevented or interfered with solely because modification has been made.

If you convey an object code work under this section in, or with, or specifically for use in, a User Product, and the conveying occurs as part of a transaction in which the right of possession and use of the User Product is transferred to the recipient in perpetuity or for a fixed term (regardless of how the transaction is characterized), the Corresponding Source conveyed under this section must be accompanied by the Installation Information. But this requirement does not apply if neither you nor any third party retains the ability to install modified object code on the User Product (for example, the work has been installed in ROM).

The requirement to provide Installation Information does not include a requirement to continue to provide support service, warranty, or updates for a work that has been modified or installed by the recipient, or for the User Product in which it has been modified or installed. Access to a network may be denied when the modification itself materially and adversely affects the operation of the network or violates the rules and protocols for communication across the network.

Corresponding Source conveyed, and Installation Information provided, in accord with this

section must be in a format that is publicly documented (and with an implementation available to the public in source code form), and must require no special password or key for unpacking, reading or copying.

#### 7. Additional Terms.

“Additional permissions” are terms that supplement the terms of this License by making exceptions from one or more of its conditions. Additional permissions that are applicable to the entire Program shall be treated as though they were included in this License, to the extent that they are valid under applicable law. If additional permissions apply only to part of the Program, that part may be used separately under those permissions, but the entire Program remains governed by this License without regard to the additional permissions.

When you convey a copy of a covered work, you may at your option remove any additional permissions from that copy, or from any part of it. (Additional permissions may be written to require their own removal in certain cases when you modify the work.) You may place additional permissions on material, added by you to a covered work, for which you have or can give appropriate copyright permission.

Notwithstanding any other provision of this License, for material you add to a covered work, you may (if authorized by the copyright holders of that material) supplement the terms of this License with terms:

- a) Disclaiming warranty or limiting liability differently from the terms of sections 15 and 16 of this License; or
- b) Requiring preservation of specified reasonable legal notices or author attributions in that material or in the Appropriate Legal Notices displayed by works containing it; or
- c) Prohibiting misrepresentation of the origin of that material, or requiring that modified versions of such material be marked in reasonable ways as different from the original version; or
- d) Limiting the use for publicity purposes of names of licensors or authors of the material; or
- e) Declining to grant rights under trademark law for use of some trade names, trademarks, or service marks; or
- f) Requiring indemnification of licensors and authors of that material by anyone who conveys the material (or modified versions of it) with contractual assumptions of liability to the recipient, for any liability that these contractual assumptions directly impose on those licensors and authors.

All other non-permissive additional terms are considered “further restrictions” within the

meaning of section 10. If the Program as you received it, or any part of it, contains a notice stating that it is governed by this License along with a term that is a further restriction, you may remove that term. If a license document contains a further restriction but permits relicensing or conveying under this License, you may add to a covered work material governed by the terms of that license document, provided that the further restriction does not survive such relicensing or conveying.

If you add terms to a covered work in accord with this section, you must place, in the relevant source files, a statement of the additional terms that apply to those files, or a notice indicating where to find the applicable terms.

Additional terms, permissive or non-permissive, may be stated in the form of a separately written license, or stated as exceptions; the above requirements apply either way.

#### 8. Termination.

You may not propagate or modify a covered work except as expressly provided under this License. Any attempt otherwise to propagate or modify it is void, and will automatically terminate your rights under this License (including any patent licenses granted under the third paragraph of section 11).

However, if you cease all violation of this License, then your license from a particular copyright holder is reinstated (a) provisionally, unless and until the copyright holder explicitly and finally terminates your license, and (b) permanently, if the copyright holder fails to notify you of the violation by some reasonable means prior to 60 days after the cessation.

Moreover, your license from a particular copyright holder is reinstated permanently if the copyright holder notifies you of the violation by some reasonable means, this is the first time you have received notice of violation of this License (for any work) from that copyright holder, and you cure the violation prior to 30 days after your receipt of the notice.

Termination of your rights under this section does not terminate the licenses of parties who have received copies or rights from you under this License. If your rights have been terminated and not permanently reinstated, you do not qualify to receive new licenses for the same material under section 10.

#### 9. Acceptance Not Required for Having Copies.

You are not required to accept this License in order to receive or run a copy of the Program.

Ancillary propagation of a covered work occurring solely as a consequence of using peer-to-peer transmission to receive a copy likewise does not require acceptance. However, nothing other than this License grants you permission to propagate or modify any covered work. These actions infringe copyright if you do not accept this License. Therefore, by modifying or propagating a covered work, you indicate your acceptance of this License to do so.

#### 10. Automatic Licensing of Downstream Recipients.

Each time you convey a covered work, the recipient automatically receives a license from the original licensors, to run, modify and propagate that work, subject to this License. You are not responsible for enforcing compliance by third parties with this License.

An "entity transaction" is a transaction transferring control of an organization, or substantially all assets of one, or subdividing an organization, or merging organizations. If propagation of a covered work results from an entity transaction, each party to that transaction who receives a copy of the work also receives whatever licenses to the work the party's predecessor in interest had or could give under the previous paragraph, plus a right to possession of the Corresponding Source of the work from the predecessor in interest, if the predecessor has it or can get it with reasonable efforts.

You may not impose any further restrictions on the exercise of the rights granted or affirmed under this License. For example, you may not impose a license fee, royalty, or other charge for exercise of rights granted under this License, and you may not initiate litigation (including a cross-claim or counterclaim in a lawsuit) alleging that any patent claim is infringed by making, using, selling, offering for sale, or importing the Program or any portion of it.

#### 11. Patents.

A "contributor" is a copyright holder who authorizes use under this License of the Program or a work on which the Program is based. The work thus licensed is called the contributor's "contributor version".

A contributor's "essential patent claims" are all patent claims owned or controlled by the contributor, whether already acquired or hereafter acquired, that would be infringed by some manner, permitted by this License, of making, using, or selling its contributor version, but do not include claims that would be infringed only as a consequence of further modification of the contributor version. For purposes of this definition, "control" includes the right to grant patent sublicenses in a manner consistent with the requirements of this

License.

Each contributor grants you a non-exclusive, worldwide, royalty-free patent license under the contributor's essential patent claims, to make, use, sell, offer for sale, import and otherwise run, modify and propagate the contents of its contributor version.

In the following three paragraphs, a "patent license" is any express agreement or commitment, however denominated, not to enforce a patent (such as an express permission to practice a patent or covenant not to sue for patent infringement). To "grant" such a patent license to a party means to make such an agreement or commitment not to enforce a patent against the party.

If you convey a covered work, knowingly relying on a patent license, and the Corresponding Source of the work is not available for anyone to copy, free of charge and under the terms of this License, through a publicly available network server or other readily accessible means, then you must either (1) cause the Corresponding Source to be so available, or (2) arrange to deprive yourself of the benefit of the patent license for this particular work, or (3) arrange, in a manner consistent with the requirements of this License, to extend the patent license to downstream recipients. "Knowingly relying" means you have actual knowledge that, but for the patent license, your conveying the covered work in a country, or your recipient's use of the covered work in a country, would infringe one or more identifiable patents in that country that you have reason to believe are valid.

If, pursuant to or in connection with a single transaction or arrangement, you convey, or propagate by procuring conveyance of, a covered work, and grant a patent license to some of the parties receiving the covered work authorizing them to use, propagate, modify or convey a specific copy of the covered work, then the patent license you grant is automatically extended to all recipients of the covered work and works based on it.

A patent license is "discriminatory" if it does not include within the scope of its coverage, prohibits the exercise of, or is conditioned on the non-exercise of one or more of the rights that are specifically granted under this License. You may not convey a covered work if you are a party to an arrangement with a third party that is in the business of distributing software, under which you make payment to the third party based on the extent of your activity of conveying the work, and under which the third party grants, to any of the parties who would receive the covered work from you, a discriminatory patent license (a) in connection with copies of the covered work conveyed by you (or copies made from those copies), or (b) primarily for and in connection with specific products or compilations that



contain the covered work, unless you entered into that arrangement, or that patent license was granted, prior to 28 March 2007.

Nothing in this License shall be construed as excluding or limiting any implied license or other defenses to infringement that may otherwise be available to you under applicable patent law.

#### 12. No Surrender of Others' Freedom.

If conditions are imposed on you (whether by court order, agreement or otherwise) that contradict the conditions of this License, they do not excuse you from the conditions of this License. If you cannot convey a covered work so as to satisfy simultaneously your obligations under this License and any other pertinent obligations, then as a consequence you may not convey it at all. For example, if you agree to terms that obligate you to collect a royalty for further conveying from those to whom you convey the Program, the only way you could satisfy both those terms and this License would be to refrain entirely from conveying the Program.

#### 13. Use with the GNU Affero General Public License.

Notwithstanding any other provision of this License, you have permission to link or combine any covered work with a work licensed under version 3 of the GNU Affero General Public License into a single combined work, and to convey the resulting work. The terms of this License will continue to apply to the part which is the covered work, but the special requirements of the GNU Affero General Public License, section 13, concerning interaction through a network will apply to the combination as such.

#### 14. Revised Versions of this License.

The Free Software Foundation may publish revised and/or new versions of the GNU General Public License from time to time. Such new versions will be similar in spirit to the present version, but may differ in detail to address new problems or concerns.

Each version is given a distinguishing version number. If the Program specifies that a certain numbered version of the GNU General Public License “or any later version” applies to it, you have the option of following the terms and conditions either of that numbered version or of any later version published by the Free Software Foundation. If the Program does not specify a version number of the GNU General Public License, you may choose any version ever published by the Free Software Foundation.

If the Program specifies that a proxy can decide which future versions of the GNU General

Public License can be used, that proxy's public statement of acceptance of a version permanently authorizes you to choose that version for the Program.

Later license versions may give you additional or different permissions. However, no additional obligations are imposed on any author or copyright holder as a result of your choosing to follow a later version.

15. Disclaimer of Warranty.

THERE IS NO WARRANTY FOR THE PROGRAM, TO THE EXTENT PERMITTED BY APPLICABLE LAW. EXCEPT WHEN OTHERWISE STATED IN WRITING THE COPYRIGHT HOLDERS AND/OR OTHER PARTIES PROVIDE THE PROGRAM "AS IS" WITHOUT WARRANTY OF ANY KIND, EITHER EXPRESSED OR IMPLIED, INCLUDING, BUT NOT LIMITED TO, THE IMPLIED WARRANTIES OF MERCHANTABILITY AND FITNESS FOR A PARTICULAR PURPOSE. THE ENTIRE RISK AS TO THE QUALITY AND PERFORMANCE OF THE PROGRAM IS WITH YOU. SHOULD THE PROGRAM PROVE DEFECTIVE, YOU ASSUME THE COST OF ALL NECESSARY SERVICING, REPAIR OR CORRECTION.

16. Limitation of Liability.

IN NO EVENT UNLESS REQUIRED BY APPLICABLE LAW OR AGREED TO IN WRITING WILL ANY COPYRIGHT HOLDER, OR ANY OTHER PARTY WHO MODIFIES AND/OR CONVEYS THE PROGRAM AS PERMITTED ABOVE, BE LIABLE TO YOU FOR DAMAGES, INCLUDING ANY GENERAL, SPECIAL, INCIDENTAL OR CONSEQUENTIAL DAMAGES ARISING OUT OF THE USE OR INABILITY TO USE THE PROGRAM (INCLUDING BUT NOT LIMITED TO LOSS OF DATA OR DATA BEING RENDERED INACCURATE OR LOSSES SUSTAINED BY YOU OR THIRD PARTIES OR A FAILURE OF THE PROGRAM TO OPERATE WITH ANY OTHER PROGRAMS), EVEN IF SUCH HOLDER OR OTHER PARTY HAS BEEN ADVISED OF THE POSSIBILITY OF SUCH DAMAGES.

17. Interpretation of Sections 15 and 16.

If the disclaimer of warranty and limitation of liability provided above cannot be given local legal effect according to their terms, reviewing courts shall apply local law that most closely approximates an absolute waiver of all civil liability in connection with the Program, unless a warranty or assumption of liability accompanies a copy of the Program in return for a fee.

END OF TERMS AND CONDITIONS