



DVI-D and USB 2.0 Extender User Manual

Extend video and USB up to 328 feet (100 m)
over CAT5e or better cable.



Contact Information

Order toll-free in the U.S. or for FREE 24/7 technical support: Call 877-877-BBOX
(outside U.S. call 724-746-5500)
www.blackbox.com • info@blackbox.com

Trademarks Used in this Manual

Trademarks Used in this Manual

Black Box and the Double Diamond logo are registered trademarks of BB Technologies, Inc.

Any other trademarks mentioned in this manual are acknowledged to be the property of the trademark owners.

We're here to help! If you have any questions about your application or our products, contact Black Box Tech Support at **877-877-2269** or go to **blackbox.com** and click on "Talk to Black Box." You'll be live with one of our technical experts in less than 60 seconds.

Federal Communications Commission and Industry Canada Radio Frequency Interference Statements

This equipment generates, uses, and can radiate radio-frequency energy, and if not installed and used properly, that is, in strict accordance with the manufacturer's instructions, may cause interference to radio communication. It has been tested and found to comply with the limits for a Class A computing device in accordance with the specifications in Subpart B of Part 15 of FCC rules, which are designed to provide reasonable protection against such interference when the equipment is operated in a commercial environment. Operation of this equipment in a residential area is likely to cause interference, in which case the user at his own expense will be required to take whatever measures may be necessary to correct the interference.

Changes or modifications not expressly approved by the party responsible for compliance could void the user's authority to operate the equipment.

This digital apparatus does not exceed the Class A limits for radio noise emission from digital apparatus set out in the Radio Interference Regulation of Industry Canada.

Le présent appareil numérique n'émet pas de bruits radioélectriques dépassant les limites applicables aux appareils numériques de la classe A prescrites dans le Règlement sur le brouillage radioélectrique publié par Industrie Canada.

Instrucciones de Seguridad (Normas Oficiales Mexicanas Electrical Safety Statement)

1. Todas las instrucciones de seguridad y operación deberán ser leídas antes de que el aparato eléctrico sea operado.
2. Las instrucciones de seguridad y operación deberán ser guardadas para referencia futura.
3. Todas las advertencias en el aparato eléctrico y en sus instrucciones de operación deben ser respetadas.
4. Todas las instrucciones de operación y uso deben ser seguidas.
5. El aparato eléctrico no deberá ser usado cerca del agua—por ejemplo, cerca de la tina de baño, lavabo, sótano mojado o cerca de una alberca, etc.
6. El aparato eléctrico debe ser usado únicamente con carritos o pedestales que sean recomendados por el fabricante.
7. El aparato eléctrico debe ser montado a la pared o al techo sólo como sea recomendado por el fabricante.
8. Servicio—El usuario no debe intentar dar servicio al equipo eléctrico más allá a lo descrito en las instrucciones de operación. Todo otro servicio deberá ser referido a personal de servicio calificado.
9. El aparato eléctrico debe ser situado de tal manera que su posición no interfiera su uso. La colocación del aparato eléctrico sobre una cama, sofá, alfombra o superficie similar puede bloquea la ventilación, no se debe colocar en libreros o gabinetes que impidan el flujo de aire por los orificios de ventilación.
10. El equipo eléctrico debe ser situado fuera del alcance de fuentes de calor como radiadores, registros de calor, estufas u otros aparatos (incluyendo amplificadores) que producen calor.
11. El aparato eléctrico deberá ser conectado a una fuente de poder sólo del tipo descrito en el instructivo de operación, o como se indique en el aparato.
12. Precaución debe ser tomada de tal manera que la tierra física y la polarización del equipo no sea eliminada.
13. Los cables de la fuente de poder deben ser guiados de tal manera que no sean pisados ni pellizcados por objetos colocados sobre o contra ellos, poniendo particular atención a los contactos y receptáculos donde salen del aparato.
14. El equipo eléctrico debe ser limpiado únicamente de acuerdo a las recomendaciones del fabricante.
15. En caso de existir, una antena externa deberá ser localizada lejos de las líneas de energía.
16. El cable de corriente deberá ser desconectado del cuando el equipo no sea usado por un largo periodo de tiempo.
17. Cuidado debe ser tomado de tal manera que objetos líquidos no sean derramados sobre la cubierta u orificios de ventilación.
18. Servicio por personal calificado deberá ser provisto cuando:
 - A: El cable de poder o el contacto ha sido dañado; u
 - B: Objetos han caído o líquido ha sido derramado dentro del aparato; o
 - C: El aparato ha sido expuesto a la lluvia; o
 - D: El aparato parece no operar normalmente o muestra un cambio en su desempeño; o
 - E: El aparato ha sido tirado o su cubierta ha sido dañada.

Table of Contents

1.	Specifications	6
2.	Overview	7
2.1	About the KVM Extender	7
2.2	What's Included	7
2.3	Requirements	7
2.4	Compatibility and Recommended Setup	7
2.5	Hardware Description.....	8
2.5.1	Local Extender Description and Markings.....	8
2.5.2	Remote Extender Description and Markings.....	9
3.	Installation	11
3.1	Installing the Local Extender Unit.....	11
3.2	Installing the Remote Extender Unit.....	11
3.3	Connecting the Local Extender to the Remote Extender	11
3.4	Connecting Power to the Local Extender and Remote Extender.....	12
3.5	Checking the Installation.....	12
3.6	Connecting a USB Device.....	12
4.	Troubleshooting	13
4.1	Troubleshooting Tips	13
4.2	Contacting Black Box	14
4.3	Shipping and Packaging.....	14
	Appendix. Technical Glossary.....	15

Chapter 1: Specifications

1. Specifications

Maximum Distance — 328 ft. (100 m) over solid-core CAT5e (or better) cable; Solid-core CAT6 or CAT7 STP recommended for best performance

Maximum USB Devices Supported — 13

USB Device Support — High-speed devices (USB 2.0): Up to 40 Mbps;

Full-speed USB devices (USB 2.0 and 1.1): Up to 12 Mbps;

Low-speed USB devices (USB 2.0 and 1.1): Up to 1.5 Mbps

USB Hub Support — Any single chain can include up to (4) USB hubs

USB Host Support — EHCI (USB 2.0) and OHCI/UHCI (USB 1.1)

Connectors — Local extender: Video: (1) 24-pin DVI-D In;

USB: (1) USB Type B;

Link: (1) RJ-45;

Remote extender: Video: (1) 24-pin DVI-D Out;

Link: (1) RJ-45;

USB: (3) USB Type A

Temperature Tolerance — Operating: +32 to +104° F (0 to +40° C);

Storage: -4 to +158° F (-20 to +70° C)

Humidity Tolerance — Operating: 20 to 80% relative humidity, non-condensing;

Storage: 10 to 90% relative humidity, non-condensing

Power — Input: 100–240-VAC adapter, 50–60 Hz;

Output: 5 VDC, 3 A (15 W)

Current Available to USB Device at Receiver Unit — 500 mA each port

Size — Local and Remote extenders: Each unit: 4.4"H x 6.9"W x 1.2"D (11.2 x 17.5 x 3 cm)

2. Overview

2.1 About the DVI-D and USB 2.0 Extender

The extender incorporates ServSwitch technology, enabling users to extend their video and USB up to 328 feet or 100 meters. The product is designed as a remote desktop or KVM (keyboard, video, mouse) extender.

The instructions in this guide assume that you have a general knowledge of computer installation procedures, familiarity with cabling requirements, and some understanding of USB devices.

NOTE: Notes provide additional information that could be useful.

CAUTION: Cautions provide important information about an operational requirement.

2.2 What's Included

- (1) Local extender unit
- (1) Remote extender unit
- (2) 5-VDC power adapters
- (1) 6-foot (1.8-m) USB cable
- (1) 5-foot (1.5-m) DVI cable
- A quick start guide

NOTE: You can also access the electronic file for the complete user guide (the document you are reading now) at www.blackbox.com.

NOTE: The product is a unique extender product and requires two power adapters, one for the local extender and one for the remote extender.

2.3 Requirements

To complete the installation, you will also need the following items that are not included with the product:

- A computer with a DVI-D/DVI-I output
- USB 1.1 or 2.0 compatible computer (host computer) with a USB compliant operating system
- USB 1.1 or 2.0 compatible device(s)
- CAT5e UTP cable with two RJ-45 connectors (if using surface cabling) OR CAT5e cabling with two information outlets and two CAT5e patch cords with RJ-45 connectors (if using premise cabling)
- DVI-D/DVI-I monitor and cable

NOTE: All references to CAT5e cable in this document refer to solid core and represent the minimum requirement. We recommend that you use solid core CAT6/CAT7 STP for best performance.

2.4 Compatibility and Recommended Setup

The product is compatible with many graphics cards, operating systems, and monitors, and supports high definition video resolutions. However, there is no guarantee that all devices will be compatible with the product, because there are a number of different factors that may impact the operation of this KVM Extender.

This product supports both USB 1.1 and 2.0 devices. These devices include: keyboards, mice, flash drives, microphones, speakers, printers, and USB 1.1 web cameras.

NOTE: USB 2.0 devices are limited to 40 Mbps of throughput. As a result, not all USB 2.0 devices will reach full performance.

Chapter 2: Overview

DVI Cables

CAUTION: Make sure that the DVI cables used with the extender have a connection between each connector's shield. If not, the extender can be damaged.

Cabling

NOTE: Minimum cable required is CAT5e solid-core. We recommend using CAT6 STP cable for best performance. Cables must be terminated with CAT6 connectors to qualify as CAT6.

Table 2-1. Maximum cable distance.

Cable Type	Maximum Distance	Notes
Solid-core CAT5e UTP	330 feet (100 m)	High susceptibility to electrical interference
Solid-core CAT5e STP		Moderate susceptibility to electrical interference
Solid-core CAT6 UTP		High susceptibility to electrical interference
Solid-core CAT6 STP		Recommended
Solid-core CAT7 STP		Recommended

Compatible Host Operating Systems:

- Windows®
- Mac® OS X
- Linux®

Peripherals:

- Keyboards, mass storage devices, mice, speakers, microphones

2.5 Hardware Description

2.5.1 Local Extender Description and Markings

The Local Extender connects to the computer using the supplied DVI and USB cable.

Figures 2-1 and 2-2 show the local extender's front and back panels. Table 2-2 describes its components.

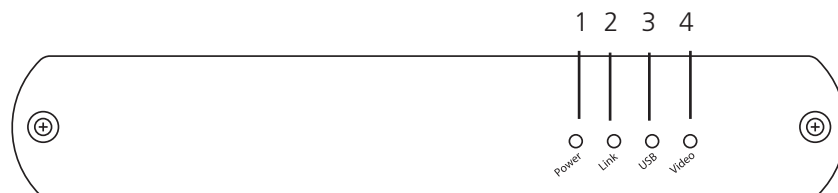

Figure 2-1. Local unit's front panel.

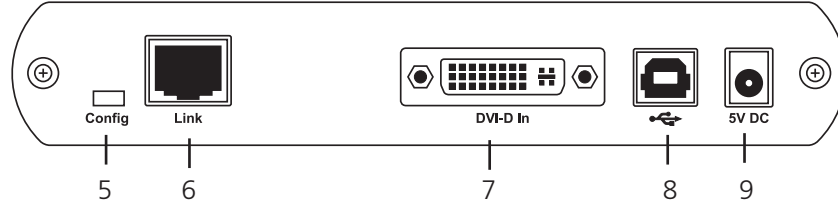

Figure 2-2. Local unit's back panel.
Table 2-2. Local unit's components.

Item	Type	Description
1	Power LED (green)	On when the system is ready. Off when no power is applied to the unit.
2	Link LED (green)	On when a valid link is established between the local and remote extender. Off when a link is not established.
3	USB LED (green)	On when the system is properly enumerated on the host computer. Blinking green indicates that the host is in suspend mode. Off when the system is not enumerated.
4	Video LED (green)	Blinking LED green indicates normal video activity. Solid green light indicates HDCP video activity. No green light (Off) indicates no video activity.
5	Config	Reserved.
6	Link Port (RJ-45)	Accepts RJ-45 connector for CAT5e (or better) cabling.
7	DVI-D In	Accepts DVI-D connector for video input from the host computer.
8	Device Port (USB Type B)	Connects the local extender unit to the host computer.
9	Power port	Connects to the 5-V, 3-A power adapter.

2.5.2 Remote Extender Description and Markings

The Remote Extender provides DVI output to a monitor and three USB Type A ports for standard USB devices. Additional devices may be connected by attaching USB hubs.

Figures 2-3 and 2-4 show the remote extender's front and back panels. Table 2-3 describes its components.

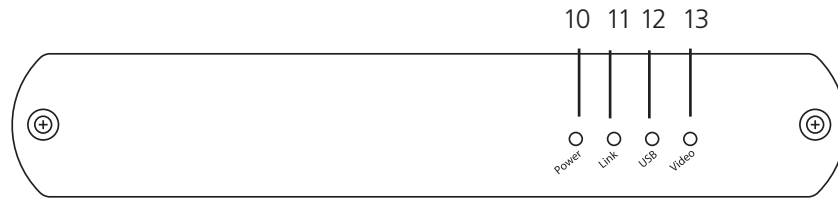

Figure 2-3. Remote unit's front panel.

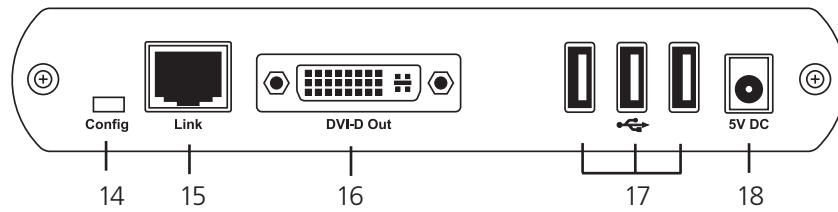

Figure 2-4. Remote unit's back panel.

Table 2-3. Remote unit's components.

Item	Type	Description
10	Power LED (green)	On when that the system is ready. Off when no power is applied to the unit.
11	Link LED (green)	On when a valid link is established between the local and remote extender. Off when a link is not established.
12	USB LED (green)	On when the system is properly enumerated on the host computer. Blinking green indicates that the host is in suspend mode. Off when the system is not enumerated.
13	Video LED (green)	Blinking LED green indicates normal video activity. Off indicates no video activity.
14	Config	Reserved.
15	Link Port (RJ-45)	Accepts RJ-45 connector for CAT5e (or better) cabling.
16	DVI-D Out	Accepts DVI-D connector to the remote monitor.
17	Device Port (USB Type A)	Accepts USB device(s).
18	Power port	Connects to the 5-V, 3-A power adapter.

3. Installation

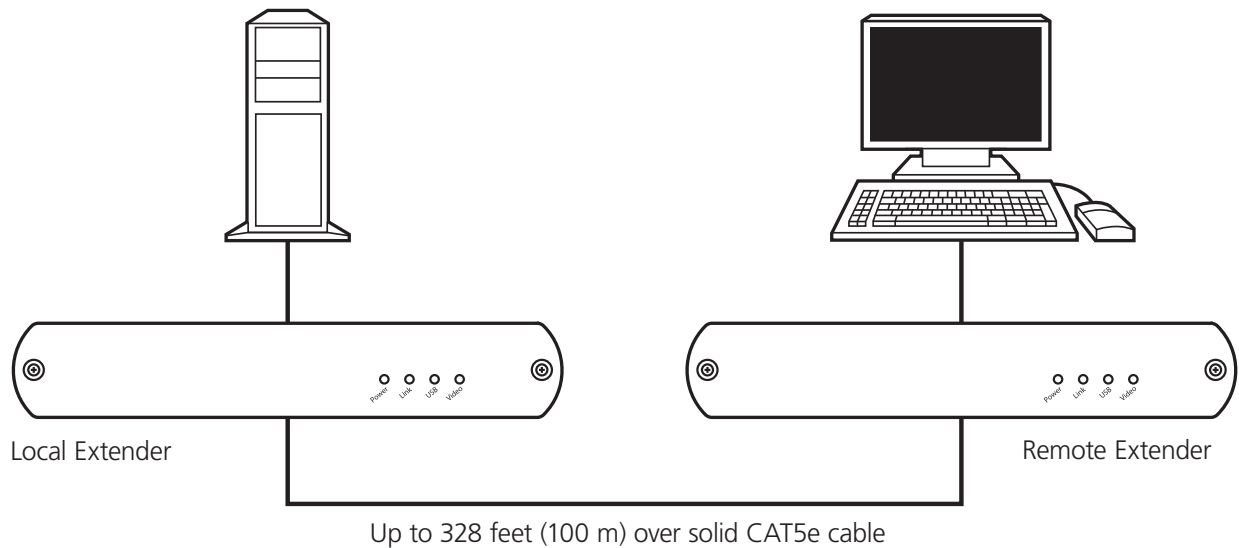

Figure 3-1. Typical installation.

Before you can install the product, you need to prepare your site:

1. Determine where the computer will be located and set up the computer.
2. Determine where you want to locate the remote desktop including the monitor, keyboard, mouse, and any other USB device(s).
3. If you are using surface cabling, the extenders support a maximum distance of 328 feet (100 m). OR if you are using premise cabling, make sure CAT5e cabling is installed between the two locations, with CAT5e information outlets located near both the computer and the USB device(s), and the total length including patch cords is no more than 328 feet (100 m).

3.1 Installing the Local Extender Unit

1. Place the Local Extender unit near the computer.
2. Connect the supplied USB cable to the Local Extender (Type B Port) and an available USB 2.0/1.1 Type A Port on the computer.
3. Connect the supplied DVI cable to the Local Extender (DVI-D In) and an available DVI Port on the computer.

3.2 Installing the Remote Extender Unit

1. Place the Remote Extender unit near the monitor and USB device(s) in the desired remote location.
2. Connect the Remote Extender DVI-D Out to the monitor with a DVI cable.
3. Plug in your USB Device(s)

3.3 Connecting the Local Extender to the Remote Extender

NOTE: For proper operation, we recommend that you use solid-core CAT6 STP cabling to connect the Local Extender unit to the Remote Extender unit. The cabling must have a straight-through conductor configuration with no crossovers and must be terminated with CAT6 connectors to qualify as CAT6.

Chapter 3: Installation

With Surface Cabling:

1. Plug one end of the CAT5e cabling (not included) into the Link port (RJ-45) on the Local Extender unit.
2. Plug the other end of the CAT5e cabling into the Link port (RJ-45) on the Remote Extender unit.

With Premise Cabling:

1. Plug one end of a CAT5e patch cord (not included) into the Link port (RJ-45) on the Local Extender unit.
2. Plug the other end of the patch cord into the CAT5e information outlet near the host computer.
3. Plug one end of the second CAT5e patch cord (not included) into the Link port (RJ-45) on the Remote Extender unit.
4. Plug the other end of the second patch cord into the CAT5e information outlet near the USB device.

3.4 Connecting Power to the Local Extender and Remote Extender

1. Plug the 5-V, 3-A power adapter into a suitable AC outlet near the Local Extender.
2. Connect the power adapter to the Local Extender.
3. Plug the 5-V, 3-A power adapter into a suitable AC outlet near the Remote Extender.
4. Connect the power adapter to the Remote Extender.

CAUTION: Use only the power adapters supplied with the product. Using substitute adapters may cause permanent damage to the system and will void the warranty.

3.5 Checking the Installation

1. On the Local Extender and Remote Extender units, check that the Power, Link, USB, and Video LEDs are on. If the Link LED is off, then the cabling between the Local Extender and Remote Extender unit is not installed properly or is defective.
2. Check to see if the USB LED is on and the Video LED is blinking or on. If they are not, this indicates there is no USB data or video data. Check the DVI and USB connections to the host computer, and the DVI connection to the monitor. Check to see if any USB devices are connected to the Remote Extender.
3. If the product is not displaying video or your USB device fails to be detected by your Operating System, consult Chapter 4, Troubleshooting.

NOTES: To open System Profiler in OS X: Open Finder, select Applications, then open the Utilities folder and double-click on the System Profiler icon.

To open Device Manager in Windows 2000 or XP: Right click "My Computer" then select: Properties >> Hardware tab >> Device Manager.

To open Device Manager in Windows Vista or Windows 7: Open the Start menu, right click on "Computer" then select: Manage >> Device Manager.

3.6 Connecting a USB Device

1. Install any software required to operate the USB device(s). Refer to the documentation for the USB device(s), as required.
2. Connect the USB device to the device port on the Remote Extender unit.
3. Check that the device is detected and installed properly in the operating system.

4. Troubleshooting

4.1 Troubleshooting Tips

Table 4-1 provides troubleshooting tips. The solutions are arranged in the order in which they should be executed in most situations. If you still can't resolve the problem after following these instructions, contact Black Box Technical Support at 724-746-5500 or info@blackbox.com.

Table 4-1. Problems/Causes/Solutions.

Problem	Cause(s)	Solution(s)
All LEDs on the local extender unit are off.	The local extender unit is not receiving power from the local extender DC adapter.	<ol style="list-style-type: none"> 1. Make sure that the DC power adapter is properly connected to the local extender unit. 2. Check that the DC adapter is connected to a live source of electrical power.
All LEDs on the remote extender unit are off.	The remote extender unit is not receiving power from the remote extender DC adapter.	<ol style="list-style-type: none"> 1. Make sure that the DC power adapter is properly connected to the remote extender unit. 2. Check that the DC adapter is connected to a live source of electrical power.
Power LED is on, while all other Link LEDs on the local extender unit and remote extender unit are off.	There is no connection between the local extender unit and the remote extender unit.	<ol style="list-style-type: none"> 1. Make sure that a CAT5e UTP or better cable is connected between the local extender unit and the remote extender unit. The connectors should be pinned straight-through, and eight conductor RJ-45 connectors should be used at both ends. 2. Connect a short CAT5e patch cord between the local extender unit and the remote extender unit to determine if the original CAT5e cable is defective. 3. Make sure that the CAT5e cable has a minimum amount of coiling (is as straight as possible).
The Link LED on the local extender unit is on, and the USB LED on the local extender unit is off.	<ul style="list-style-type: none"> • The host computer is not powered on. • The local extender unit is not connected to the computer. • The computer does not support USB hubs. • The unit is malfunctioning. • The USB cable is defective. 	<ol style="list-style-type: none"> 1. Disconnect all USB devices from the remote extender unit. 2. Disconnect the local extender unit from the computer. 3. Disconnect the local extender and remote extender units from the DC power adapters. 4. Reconnect the local extender unit to the DC power adapter. 5. Reconnect the remote extender unit to the DC power adapter. 6. Reconnect the USB devices to the remote extender unit. 7. Reconnect the local extender unit to the computer. 8. If the USB LED is still off, contact Black Box Technical Support at 724-746-5500 or info@blackbox.com.
All LEDs on both the local extender unit and remote extender unit are on, but the USB device does not operate correctly or is detected as an "unknown device" in the operating system.	<ul style="list-style-type: none"> • The USB device is malfunctioning. • The computer does not recognize the USB device. • The application software for the device is not operating. • The KVM extender is malfunctioning. 	<ol style="list-style-type: none"> 1. Disconnect the KVM extender from the computer. 2. Connect the USB device directly to the USB port on the computer. 3. If the device does not operate properly, consult the user documentation for the device. 4. Update your system BIOS, chipset, or USB host controller drivers from your system/motherboard manufacturer's Web site. 5. Make sure that the operating system has all the latest updates installed. 6. If the device operates properly when directly connected to the computer, connect another device (of a different type) to the KVM extender. Connect the KVM extender to the computer. 7. If the second device does not operate, the KVM extender may be malfunctioning. Contact Black Box Technical Support at 724-746-5500 or info@blackbox.com. 8. If the second device does operate properly, the first device may not be compatible with the KVM extender.

Table 4-1 (continued). Problems/Causes/Solutions.

Problem	Cause(s)	Solution(s)
Blinking video on the sink (monitor).	A high-quality CAT5e cable is not being used.	<ol style="list-style-type: none">1. Remove all loops in the CAT5e cable.2. Confirm extender operation with a CAT5e patch cable.
Video frames are being dropped.	The extender is not compatible with the source and/or sink device.	Contact Black Box Technical Support at 724-746-5500 or info@blackbox.com.
Video LED is off.	<ul style="list-style-type: none">• One or both of the DVI cables are not connected, are of poor quality, or are malfunctioning.• The sink or source is not supported.• The KVM extender is malfunctioning.	<ol style="list-style-type: none">1. Confirm extender operation with DVI cables that are less than 6.5-ft. (2-m) long and have a connection between each connector's shield.2. Confirm extender operation with a CAT5e patch cable.3. Contact Black Box Technical Support at 724-746-5500 or info@blackbox.com.

4.2 Contacting Black Box

If you determine that your extender is malfunctioning, do not attempt to alter or repair the unit. It contains no user-serviceable parts. Contact Black Box Technical Support at 877-877-2269 or info@blackbox.com.

Before you do, make a record of the history of the problem. We will be able to provide more efficient and accurate assistance if you have a complete description, including:

- the nature and duration of the problem.
- when the problem occurs.
- the components involved in the problem.
- any particular application that, when used, appears to create the problem or make it worse.

4.3 Shipping and Packaging

If you need to transport or ship your extender:

- Package it carefully. We recommend that you use the original container.
- If you are returning the unit, make sure you include everything you received with it. Before you ship for return or repair, contact Black Box to get a Return Authorization (RA) number.

Appendix. Technical Glossary

Category 5 (CAT5e) Network Cabling — Category 5 cable is commonly also referred to as CAT5e. This cabling is available in either solid or stranded twisted pair copper wire variants and as UTP (Unshielded Twisted Pair) or STP (Shielded Twisted Pair). UTP cables are not surrounded by any shielding, making them more susceptible to electromagnetic interference (EMI). STP cables include shielding over each individual pair of copper wires and provides better protection against EMI. Category 5 has been superseded by CAT5e cabling which includes improved data integrity to support high-speed communications.

USB Cables — USB cables have two distinct connectors. The Type A connector is used to connect the cable from a USB device to the Type A port on a computer or hub. The Type B connector is used to attach the USB cable to a USB device.

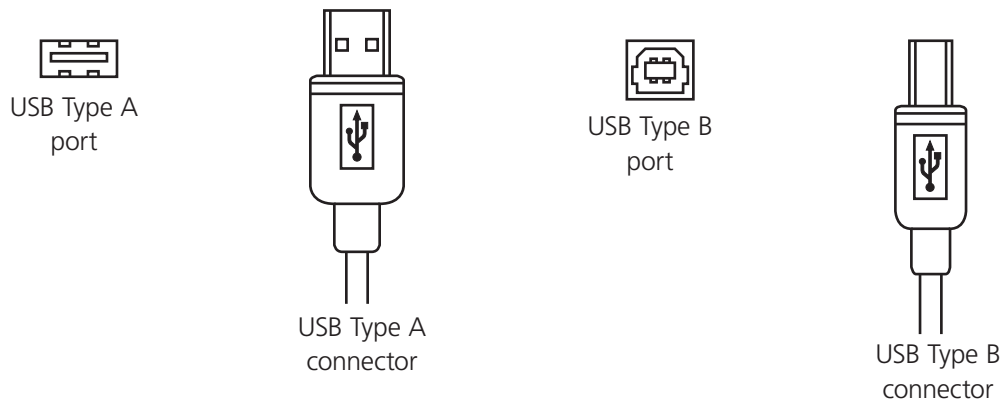

Figure A-1. USB connectors.

RJ-45 — The Registered Jack (RJ) physical interface is what connects the network cabling (CAT5e) to the local unit and remote unit. You may use either the T568A scheme (Table A-1) or the T568B scheme (Table A-2) for cable termination because the extender uses all four pairs of the cable. RJ-45 connectors are sometimes also referred to as 8P8C connectors.

Appendix: Technical Glossary

RJ-45 Pin Positioning

Table A-1. T568A Wiring.

Pin	Pair	Wire	Cable Color
1	3	1	white/green
2	3	2	green
3	2	1	white/orange
4	1	2	blue
5	1	1	white/blue
6	2	2	orange
7	4	1	white/brown
8	4	2	brown

Table A-2. T568B Wiring.

Pin	Pair	Wire	Cable Color
1	2	1	white/orange
2	2	2	orange
3	3	1	white/green
4	1	2	blue
5	1	1	white/blue
6	3	2	green
7	4	1	white/brown
8	4	2	brown

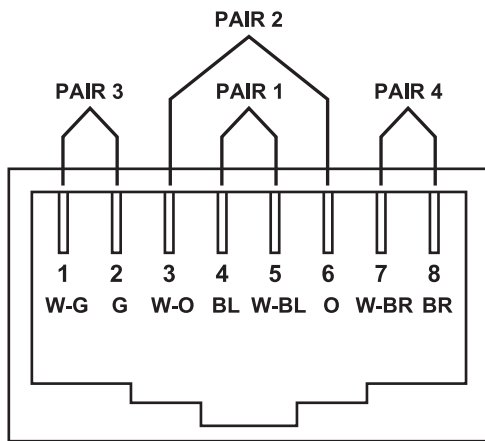

Figure A-2. T568A wired connector.

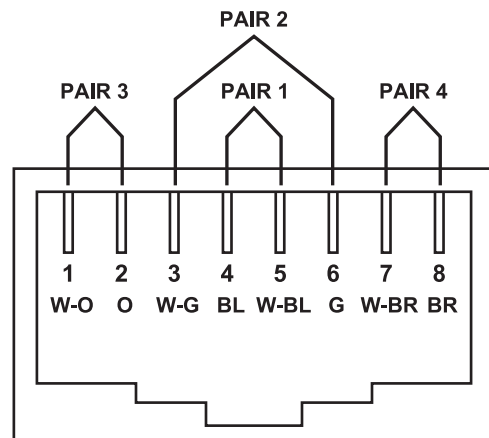

Figure A-3. T568B wired connector.

Black Box Tech Support: FREE! Live. 24/7.

Tech support the
way it should be.



Great tech support is just 60 seconds away at 877-877-2269 or blackbox.com.



About Black Box

Black Box provides an extensive range of networking and infrastructure products. You'll find everything from cabinets and racks and power and surge protection products to media converters and Ethernet switches all supported by free, live 24/7 Tech support available in 60 seconds or less.

© Copyright 2016. Black Box Corporation. All rights reserved. Black Box® and the Double Diamond logo are registered trademarks of BB Technologies, Inc. Any third-party trademarks appearing in this white paper are acknowledged to be the property of their respective owners.