

DESCRIPTION

RECOMMENDED PANEL THICKNESS 1.60±0.1

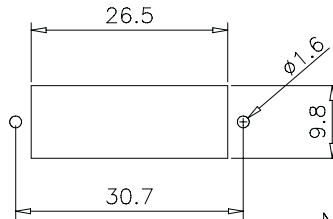
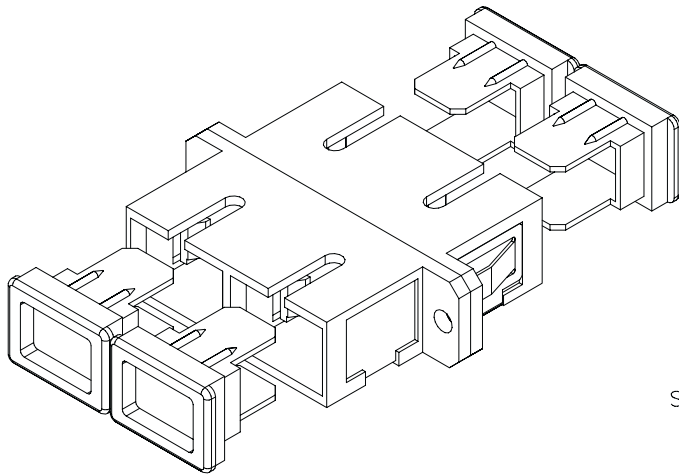

SUGGESTED PANEL CUTOUT

MECHANICAL :

	<i>MATERIAL</i>	<i>Q'TY</i>
1. SC HOUSING	PBT(UL 94-V0) Ivory Color	2
2. HOLDER	PBT(UL 94-V0)	4
3. SLEEVE	PHOSPHOR BRONZE	2
4. CLIP	STAINLESS	1
5. DUST COVER	PP	4

NOTE: TOL ± 0.1 m/m



**DIGITAL DATA
COMMUNICATIONS**

SC-Duplex Adapter/Coupler Multimode, beige