

48.840

48.843

v1.6

Installation manual/Installatie handleiding
 Installations-Handbuch/Manuel d'installation
 Manuale d'installazione/Manual de instalación
 Copyright © 2024 – Dataflex International BV

T +31 180 515444
info@dataflex-int.com
www.dataflex-int.com

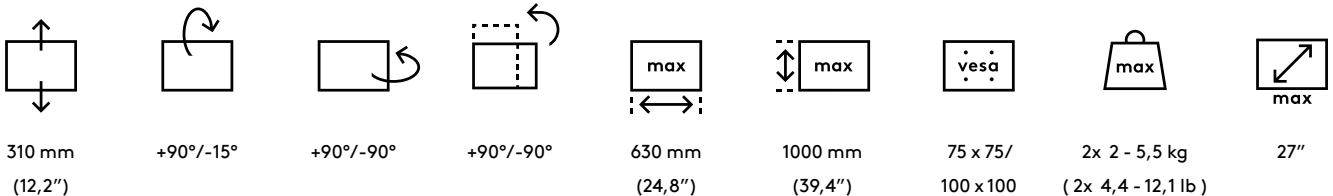

Parts/Onderdelen/Teile/Pièces/Parti/Partes

a 1x	b 1x	c 1x	d 1x	e M8x85 1x	f 1x	g 1x	h 2x	i M4x12 8x
t1 6mm 1x	t2 3 & 4mm 1x							

Optional tools for step b3/Optioneel gereedschap voor stap b3/Optionale Werkzeuge für Schritt b3
 Outils optionnels pour l'étape b3 /Strumenti facoltativi per il passaggio b3/Herramientas opcionales para el paso b3

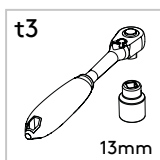

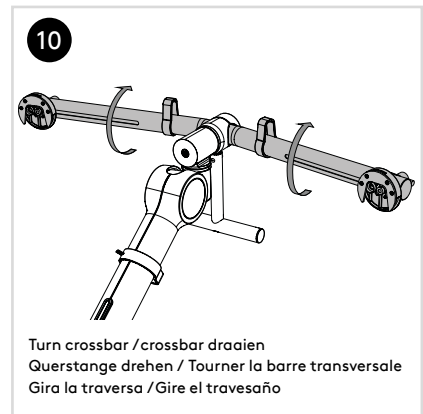
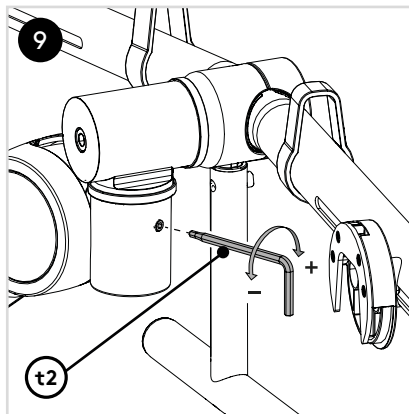
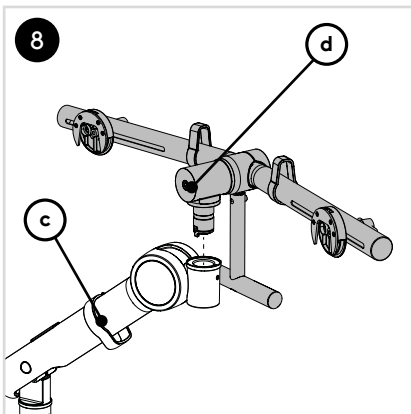
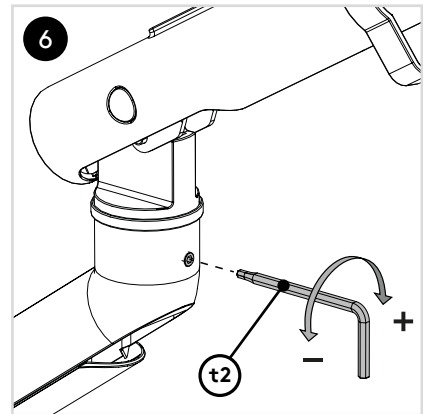
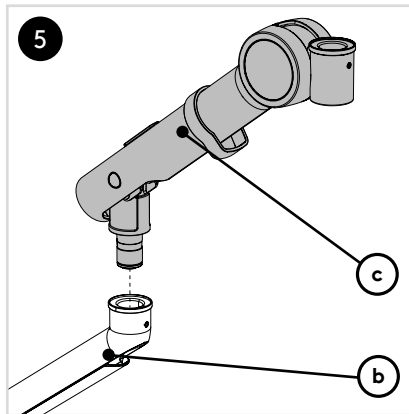
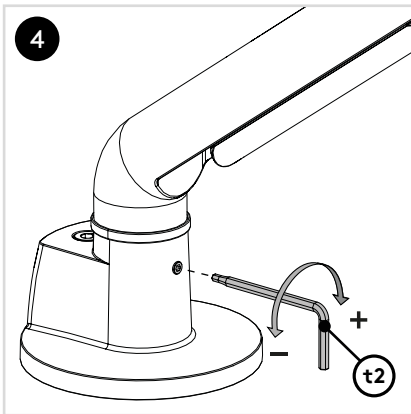
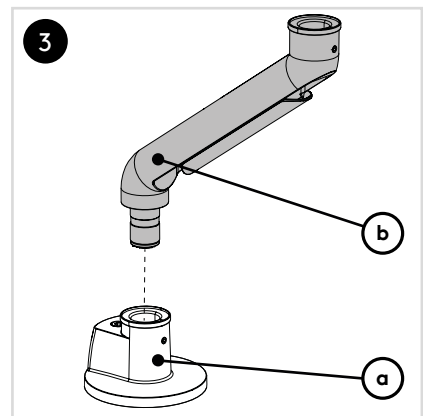
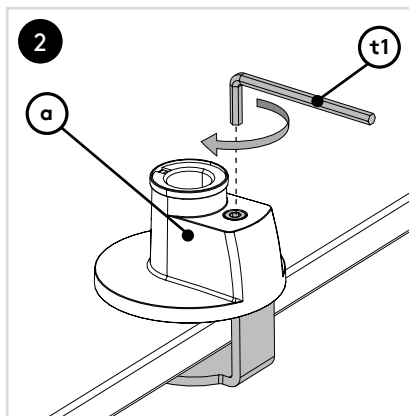
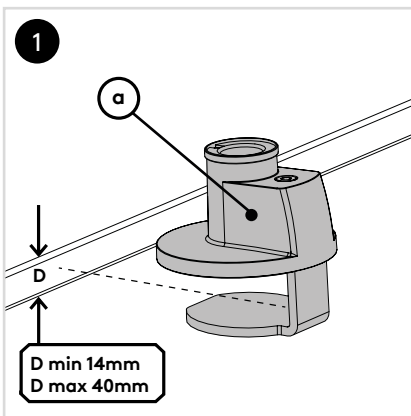
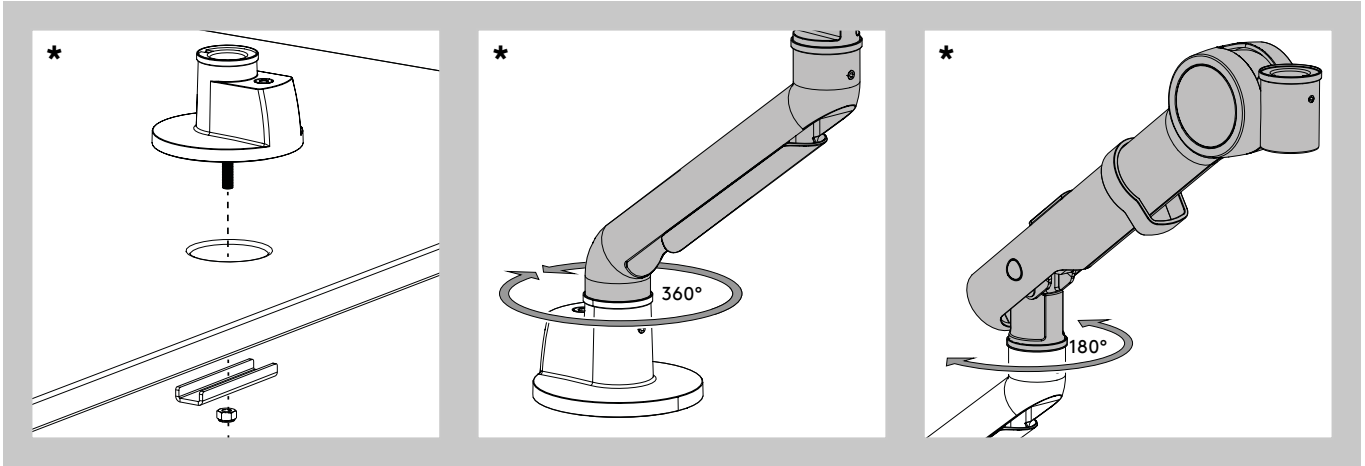

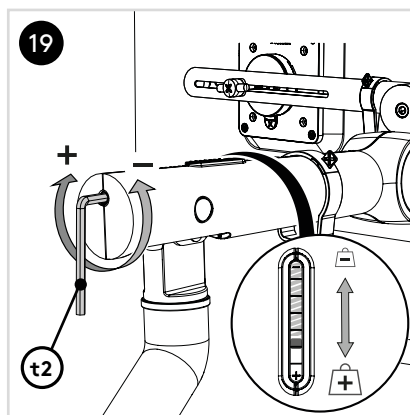
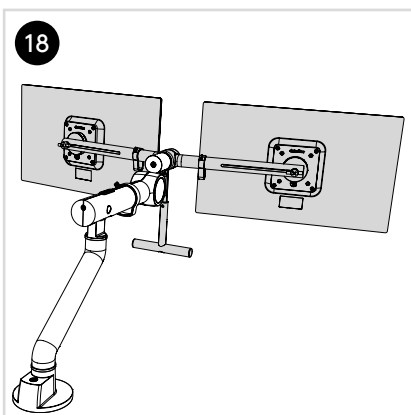
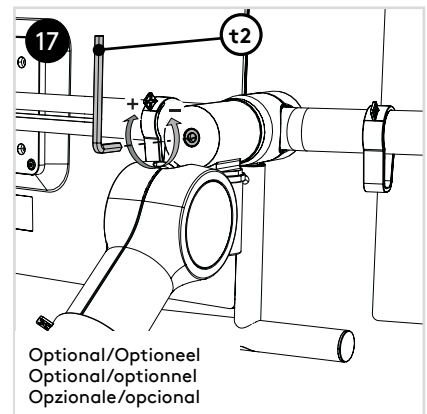
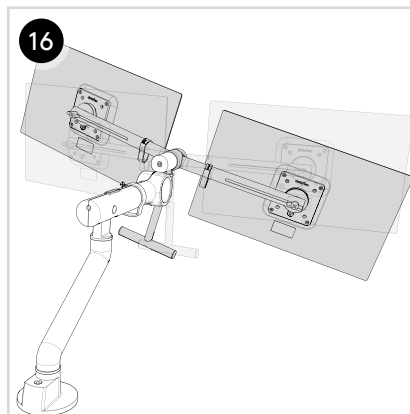
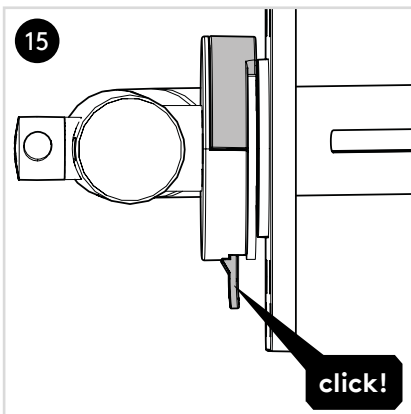
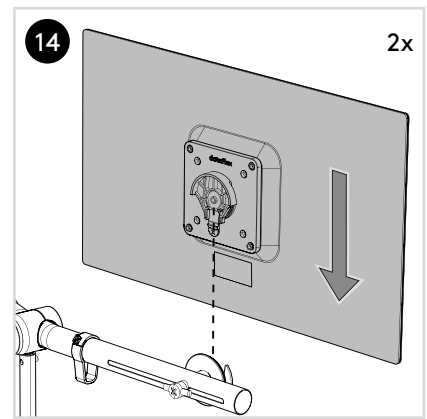
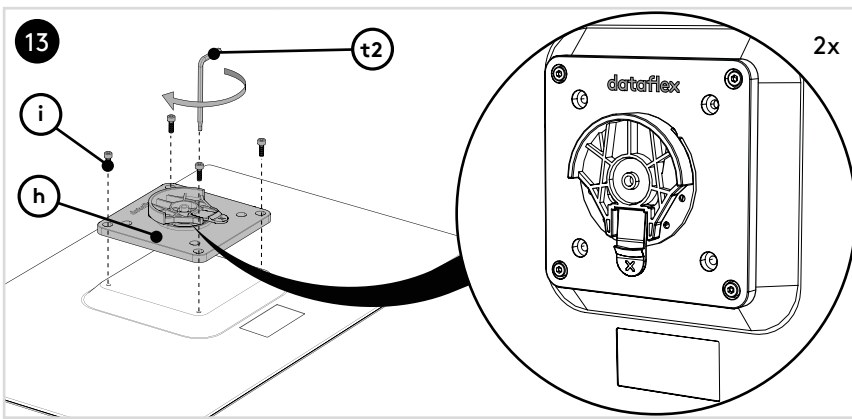
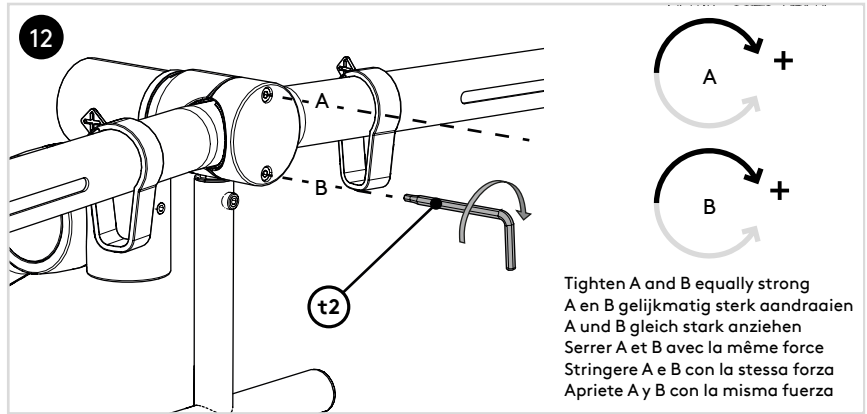
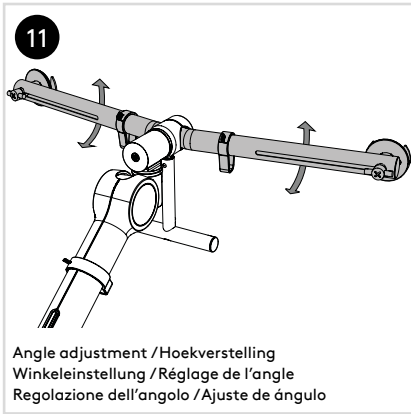

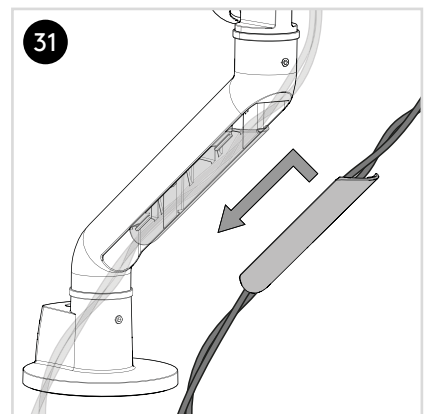
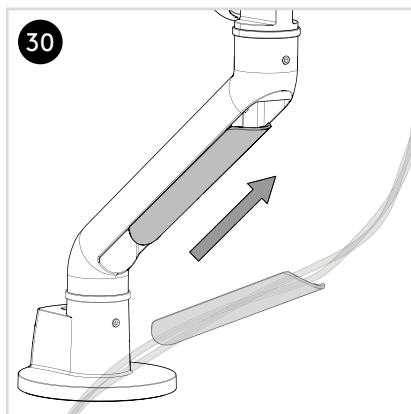
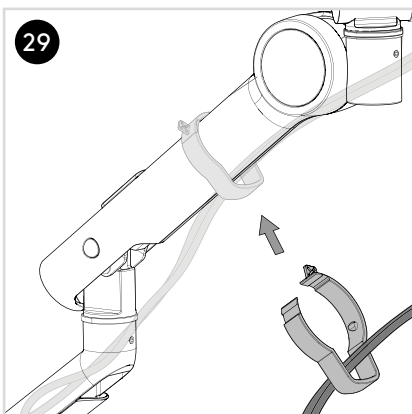
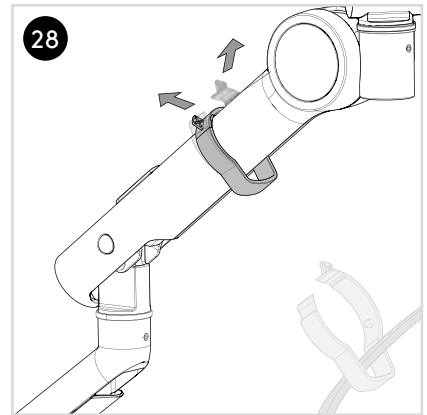
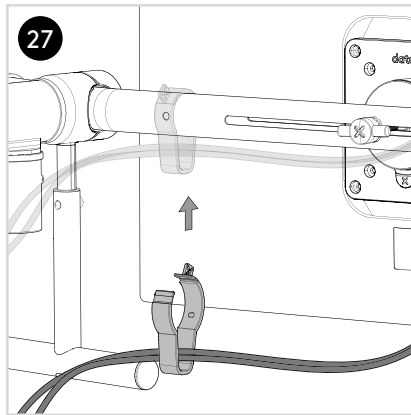
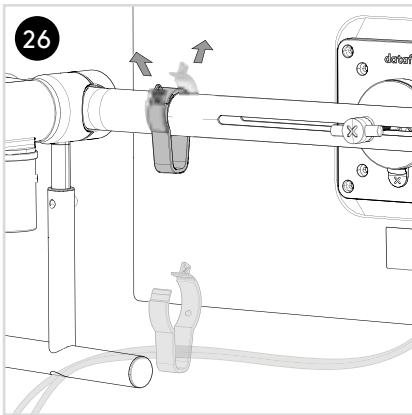
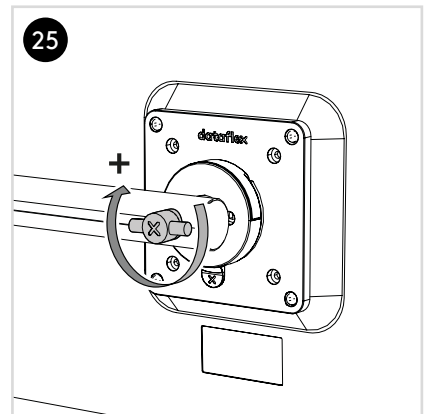
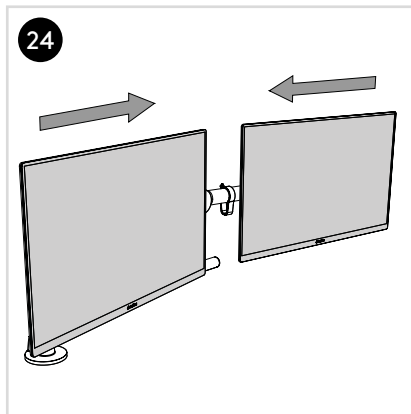
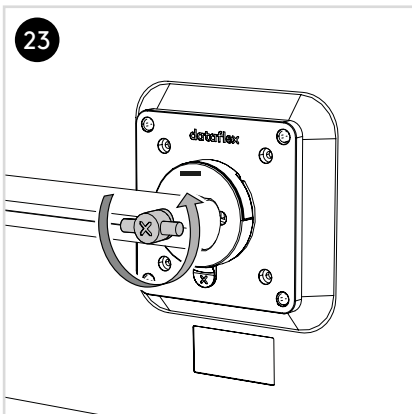
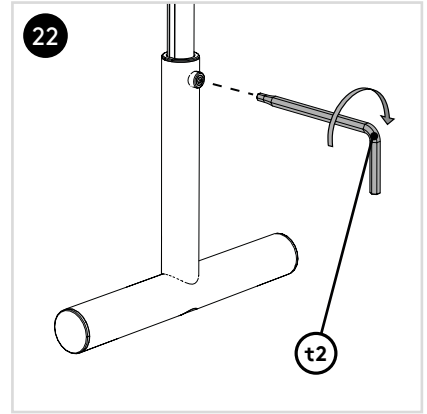
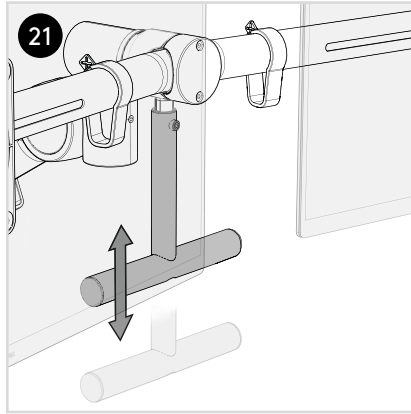
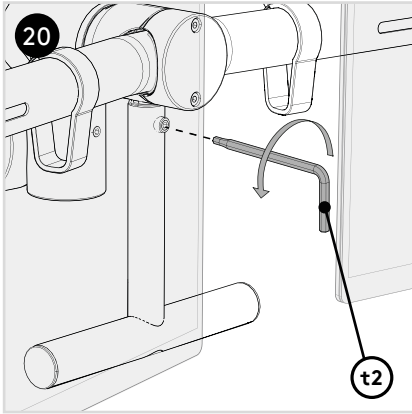

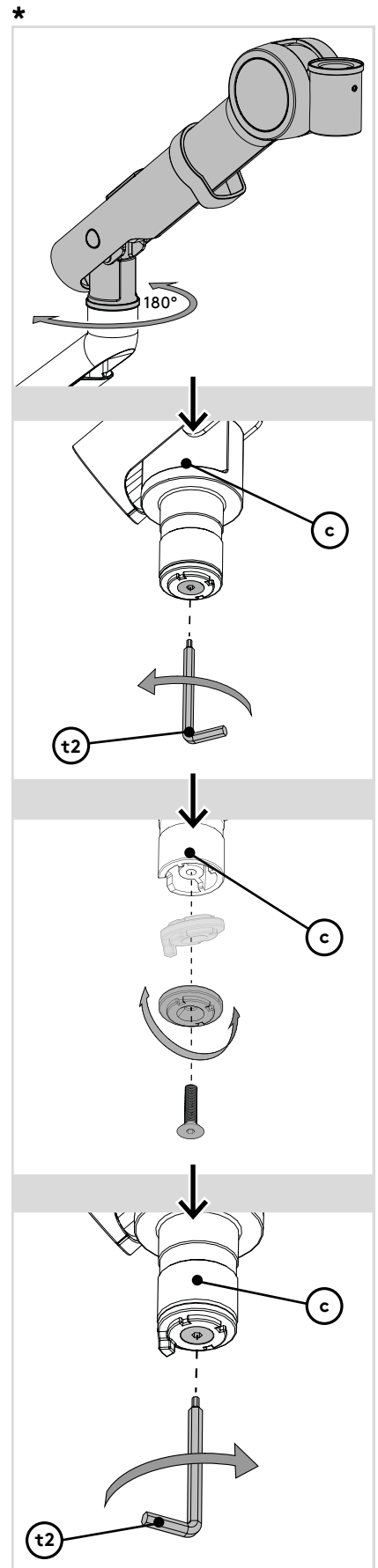
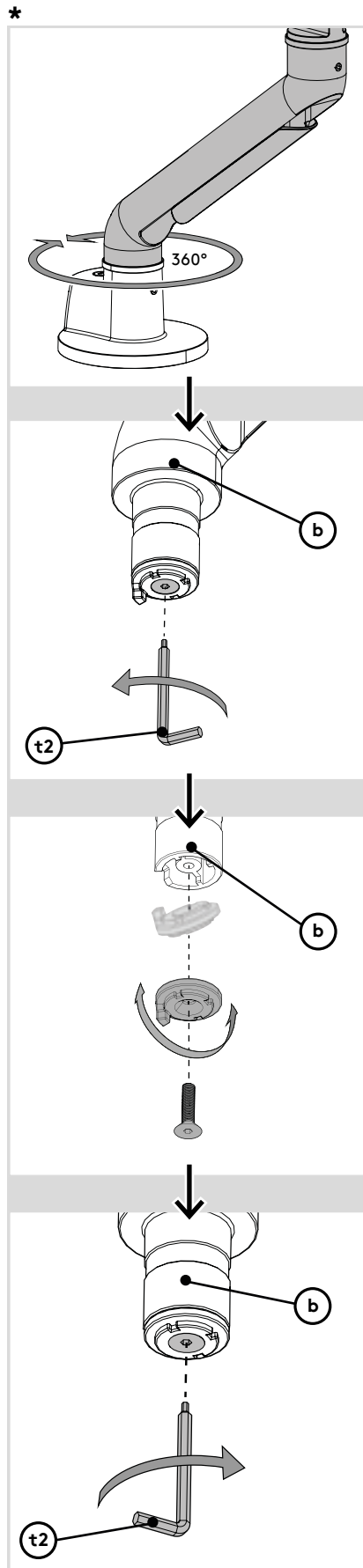
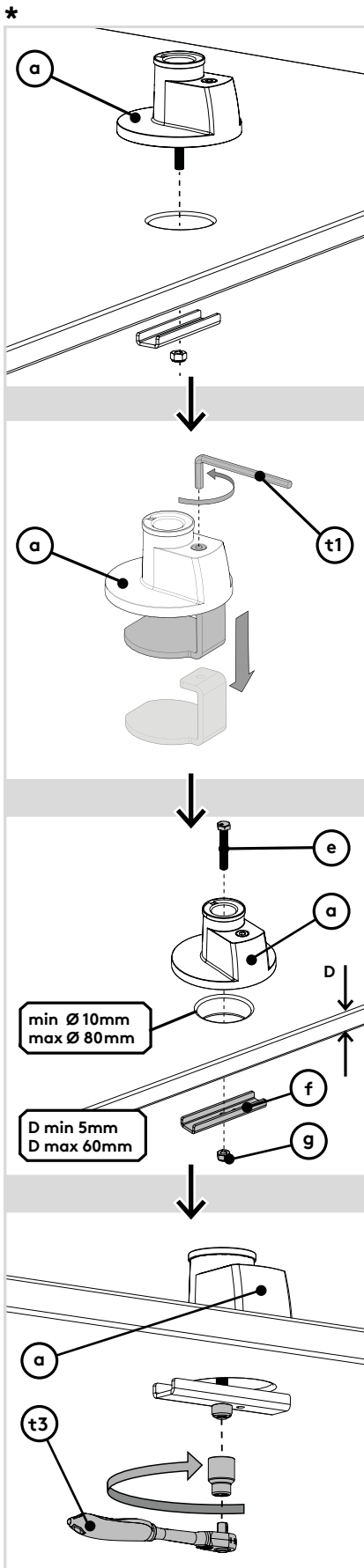

No rights can be derived from this publication/
Aan deze uitgave kunnen geen rechten worden
ontleend/Aus dieser Ausgabe können keine
Rechte abgeleitet werden/Aucun droit ne peut
découler de cette publication/Dal presente
documento non deriva alcun diritto/Del
contenido de esta publicación no podrá
derivarse ningún derecho