

CyberPower

INSTALLATION AND OPERATION MANUAL

BPS240V7ART3U

BPS240V9ART3U

BPS192V7ART3U

BPS192V9ART3U

TABLE OF CONTENTS

SAFETY INSTRUCTIONS	1
Product Safety.....	1
INTRODUCTION	2
UPS Extended Battery Modules.....	2
Unpacking Procedures.....	2
What's In The Box.....	3
EXTENDED BATTERY MODULE INSTALLATION	4
Battery Module.....	4
Connection With UPS.....	4
Extended Battery Modules Configuration.....	5
HARDWARE INSTALLATION	6
Rackmount Installation.....	6
Vertical/ Tower Installation.....	10
MAINTENANCE.....	11
Storage.....	11
Safety Precautions.....	11
Battery Disposal.....	11
Battery Replacement.....	11
TECHNICAL SPECIFICATIONS.....	14

SAFETY INSTRUCTIONS

SAVE THESE INSTRUCTIONS

Please read this manual and follow the instructions for installation and operation.

PRODUCT SAFETY



CAUTION

A battery can present a risk of electric shock and high short circuit current. The following precaution should be observed when working on batteries:

- Remove watches, rings or other metal objects.
- Use tools with insulated handles.
- Wear rubber gloves and boots.

Do not lay tools or metal parts on top of batteries.

Disconnect the AC power prior to connecting or disconnecting terminals.

Ensure the ground terminal is disconnected during installation and maintenance to reduce likelihood of shock. If the battery is installed and grounded, disconnect the ground terminal before working on the UPS.



RISK OF ELECTRIC SHOCK

See Installation Instructions Before Connecting To The Supply.

Do Not Disconnect the Battery Connector Under Load.

Batteries are replaceable by SERVICE PERSONNEL.



BATTERY

Do not dispose of batteries in a fire as the battery may explode.

Do not open or mutilate the battery, released electrolyte is harmful to the skin and eyes.

INTRODUCTION

UPS EXTENDED BATTERY MODULES

Extended Battery Modules (EBMs) from CyberPower (BPS240V7ART3U, BPS240V9ART3U, BPS192V7ART3U, BPS192V9ART3U) increase battery runtimes during power outages. Each rack/tower convertible EBM uses 3U of rack space, depending upon the model, and can be installed in a tower form factor to match the UPS installation. The DC plug-and-play power connectors allow to daisy-chain additional EBMs to a UPS system.

UNPACKING PROCEDURES



Information, advice, help

The equipment is very heavy, please handle it with care. Wear safety shoes and use a hydraulic equipment lift if one is available. At least two people are required for all handling operations, including unpacking, lifting, and installation in a rack system. Do not use the lifting straps to carry the unit around; they are provided to manually unpack the unit only.

Inspect it for shipping damage. If any shipping damage is found, report it to the carrier and your local dealer immediately.

Check the accessories included against the packing list. If there is any discrepancy, contact your local dealer immediately.

INTRODUCTION

WHATS IN THE BOX

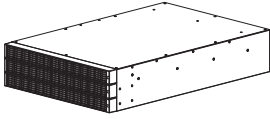

1

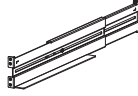

2

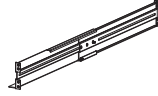

3

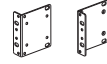

4



5

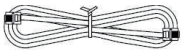

6



7



8



9



10



11

#	CONTENT	QTY
1	EBM	1
2	Rackmount Left Rail	1
3	Rackmount Right Rail	1
4	Rackmount Ears	2
5	User's Manual	1
6	Phone Cable	1
7	Flat Head Screws: M4X8L	9
8	Pan Head Screws: M5X12L	15
9	Plastic Washers	9
10	Screw hole dust covers	14
11	Truss Head Screws: M3X6L	3

EXTENDED BATTERY MODULE INSTALLATION

BATTERY MODULE

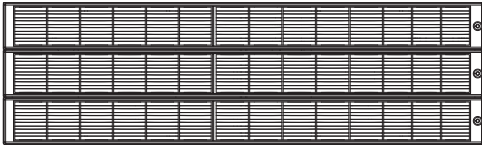

Front Panel

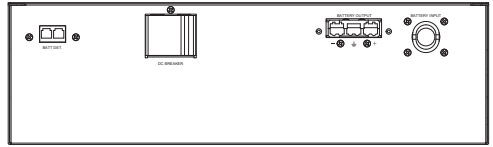

Rear Panel

CONNECTION WITH UPS

1. UPS with one Extended Battery Module (EBM)

Step 1: Turn off the DC breaker on the EBM.

Step 2: Loosen the two screws to remove the battery cable retention bracket of the UPS. Use the output cable of the EBM to connect the EBM to the UPS.

Step 3: Use the phone cable to connect the “BATT DEP.” port between UPS and EBM for EBM quantity auto-detection.

Step 4: Turn on the DC breaker of the EBM.

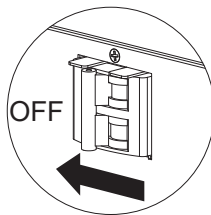

*with OLS6/10KERT4U

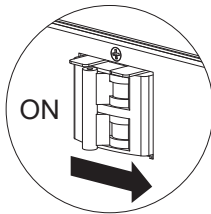
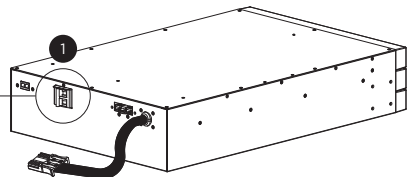

*with OLS6/10KERT5U

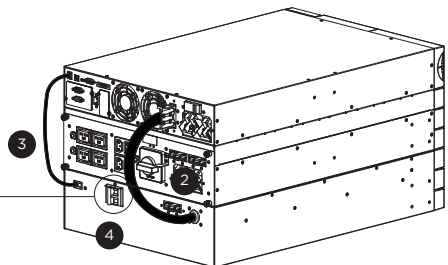
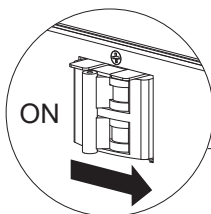
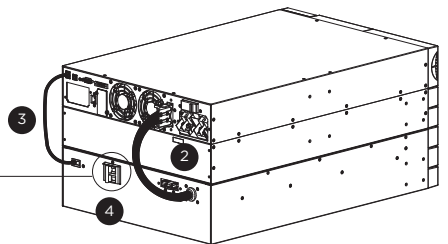

EXTENDED BATTERY MODULE INSTALLATION

2. UPS with multiple Extended Battery Modules (EBMs)

*with OLS6/10KERT4U

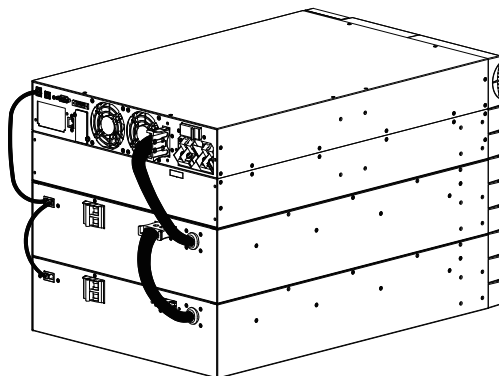

*with OLS6/10KERT5U

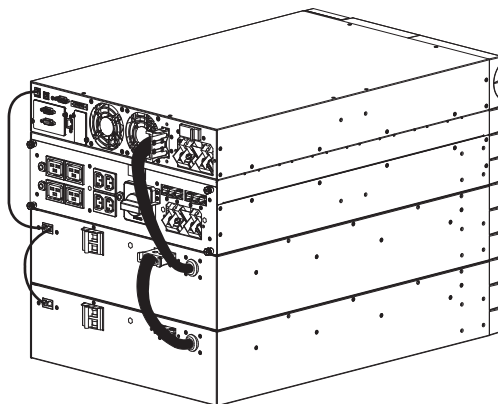

EXTENDED BATTERY MODULES CONFIGURATION

Extended Battery Modules can be configured by the user to display correct estimated battery runtimes.

CONFIGURATION ITEM	AVAILABLE SETTING	DEFAULT SETTING
C25 - EBM Number	Autodetect, 0-10 pack(s)	Autodetect

HARDWARE INSTALLATION

RACKMOUNT INSTALLATION



RISK OF FALLING EQUIPMENT



Caution - Important Instructions: Must always be followed.

CyberPower Extended Battery Module (EBM) can be installed in a rackmount or vertical/tower orientation. This versatility is especially important to growing organizations with changing needs that value having the option to position an EBM on the floor or in a rackmount system. Please follow the instructions below for the respective mounting methods.

The EBM is very heavy. Please handle it with care.

- Always practice safe lifting techniques adequate for the weight of the equipment.
- To prevent the risk of fire or electric shock, only use the supplied hardware to attach the mounting brackets.
- The battery packs are heavy. Removing the battery packs before installing the EBM is recommended.

HARDWARE INSTALLATION

Step 1: Remove the Front Panel of the Battery Module

Loosen the screw on the right side of the 1U panel to open the plastic front panel.

Step 2: Disconnect the Battery Connectors

Step 3: Loosen Eight Screws to Remove the Battery Compartment Covers

Step 4: Pull Out the Battery Packs

Pull the battery packs out slowly on to a flat and stable surface. Set them aside for reinstalling after that the EBM is rack mounted.

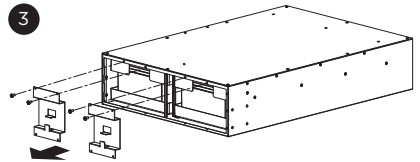
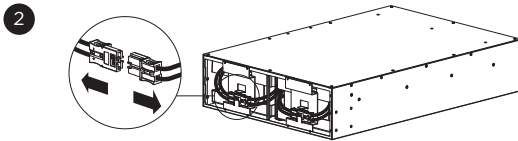
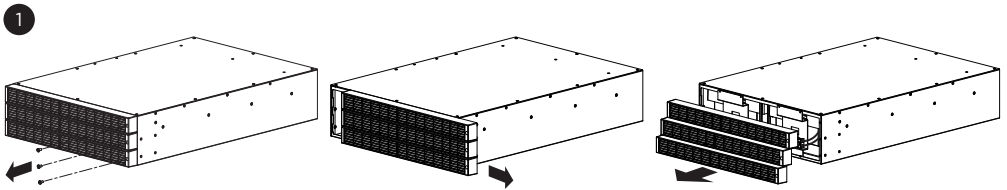

4 *battery packs of
BPS240V7ART3U/BPS240V9ART3U

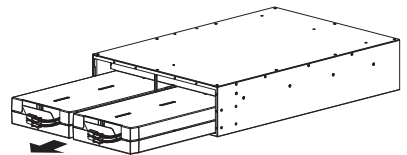

*battery packs of
BPS192V7ART3U/ BPS192V9ART3U

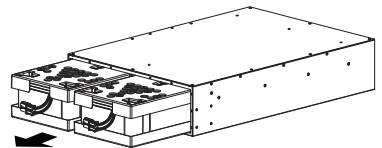

HARDWARE INSTALLATION

Step 5: Rackmount Ears Installation

Attach two rackmount ears to the EBM using eight M4X8 flat head screws.

5

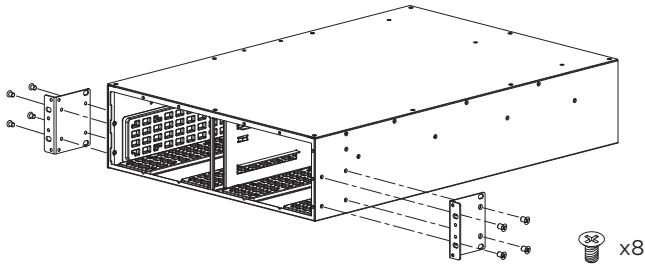

Step 6: Rackmount Rail Installation

The mounting depth of the included rackmount rails can adjust from 20.5 in to 36 in (52 cm to 91.5 cm).

Step 6-1: Select the proper holes in the rack for positioning the EBM in the rack. The EBM takes up 3 rack units.

Step 6-2: Using M3X6L and M5X12L screws to adjust rail depth to match your rack depth.

Step 6-3: Attach each rackmount rail to your rack with two M5X12L screws and two plastic washers at the front of the rack (square holes 1 and 6 as shown). Secure each side of the rackmount by the same step.

6

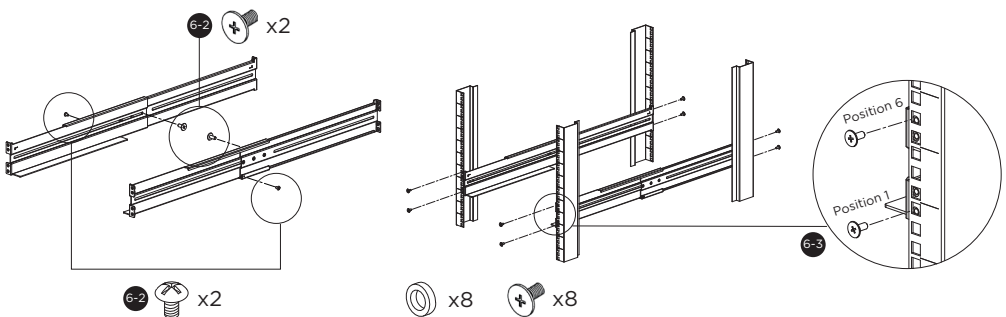

HARDWARE INSTALLATION

Step 7: Place and Secure the EBM on the Rails

Place the EBM on a flat stable surface with the front of the unit facing toward you. Secure the EBM to your rack with four M5X12L screws at the front of the rack. (square holes 2 and 5 as shown).

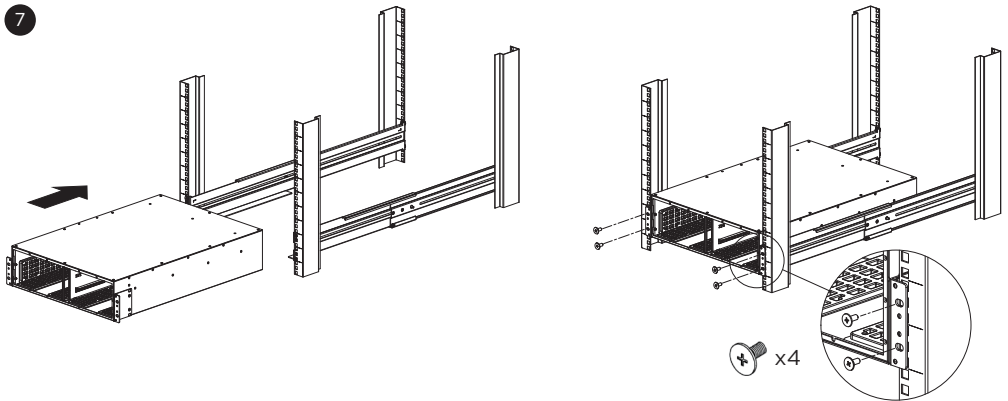

Step 8: Re-install the battery packs (if the battery packs were removed before installation)

Step 8-1: Put the battery trays into the compartment.

Step 8-2: Re-install the battery compartment cover and the plastic sheet by tightening the screws. Please make sure the connection is properly seated.

Step 8-3: Connect the battery connectors and secure them to the battery compartment.

Step 8-4: Re-install the front panels and tighten them with screws.

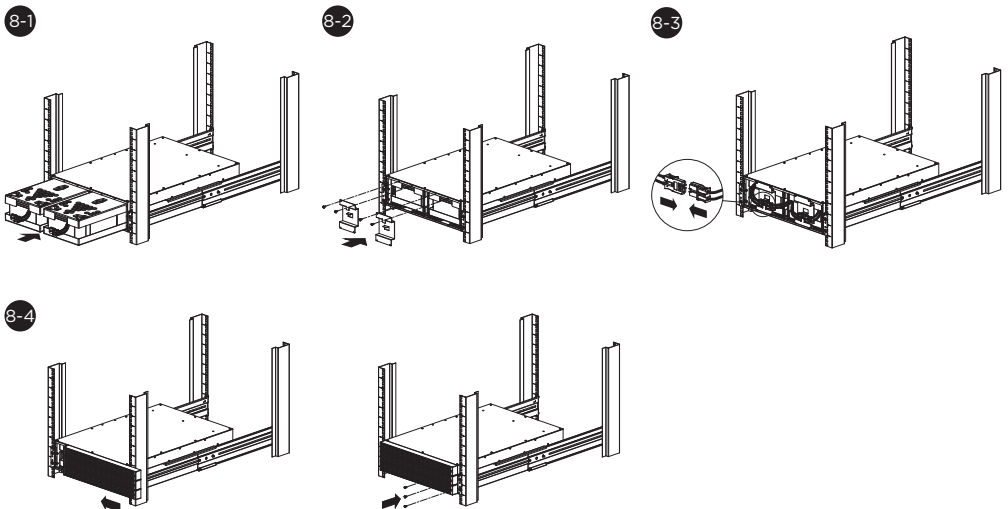

HARDWARE INSTALLATION

VERTICAL/TOWER INSTALLATION

Step 1: Attach the Base Stands

Stand the EBM on its side and attach the tower stands (rackmount ears) using four M4X8L screws onto the bottom of the it.

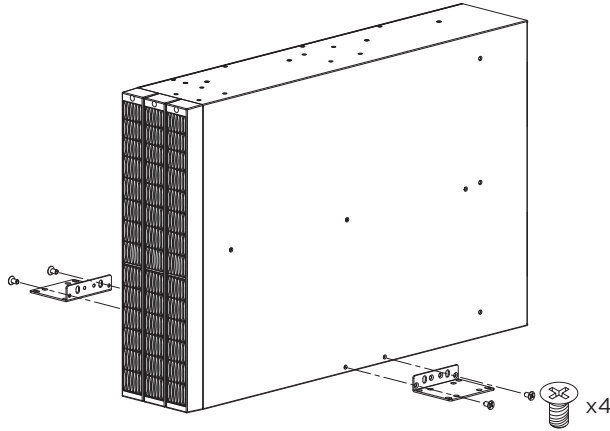

Step 2: Attach the Dust Covers

Insert the dust covers into the open screw holes on the top and side cover.

*battery packs of
BPS240V7ART3U/ BPS240V9ART3U

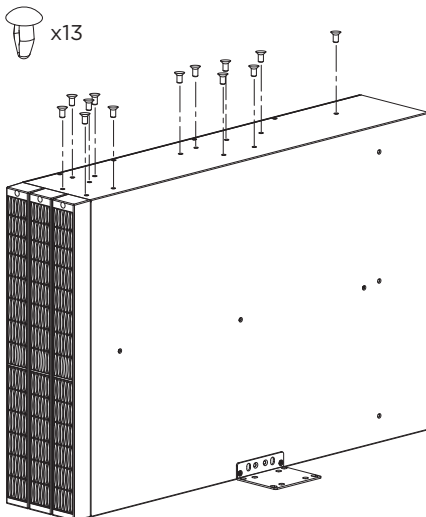

*battery packs of
BPS192V7ART3U/ BPS192V9ART3U

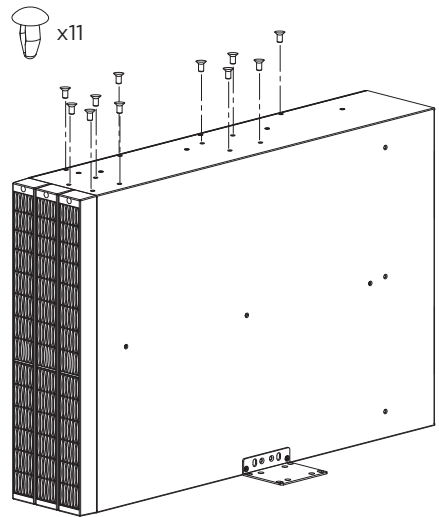

MAINTENANCE

STORAGE

To store your EBM for an extended period, cover it and store with the battery fully charged. Recharge the battery every three months to ensure battery life.

SAFETY PRECAUTIONS



Warning: High voltage – Risk of Electric Shock

CAUTION! Only use replacement batteries that are certified by Cyber Power Systems. Use of incorrect battery type is an electrical hazard that could lead to explosion, fire, electric shock, or short circuit.

CAUTION! Batteries contain an electrical charge that can cause severe burns. Before servicing batteries, please remove any conductive materials such as jewelry, chains, wrist watches, and rings.

CAUTION! Do not open or mutilate the batteries. Electrolyte fluid is harmful to the skin/eyes and may be toxic.

CAUTION! To avoid electric shock, turn off and unplug the UPS from the wall receptacle before servicing the battery.

CAUTION! Only use tools with insulated handles. Do not lay tools or metal parts on top of the UPS or battery terminals.

BATTERY DISPOSAL



Do Not Discard

Batteries are considered hazardous waste and must be disposed of properly. Contact your local government for more information about proper disposal and recycling of batteries.

Do not dispose of batteries in fire.

Cyber Power Systems encourages environmentally sound methods for disposal and recycling of its UPS products.

Please dispose and/or recycle your UPS and batteries in accordance with local regulations.

BATTERY REPLACEMENT

For battery procurement, go to www.CyberPower.com, or contact your local dealer.

When the Replace Battery the LCD displays Service Battery, use PowerPanel Business Agent software or log on to the RMCARD to perform a runtime calibration to verify battery capacity is sufficient and acceptable.

MAINTENANCE

Please read and follow the Safety Instructions before servicing the battery. Battery replacement should be performed by trained personnel who are familiar with the procedures and safety precautions. Make a note of the Replacement Battery part number.

• **NOTE:** Before replacing battery packs, please make sure that the form factor of the EBM is installed as rack type.

Step 1: Remove the Front Panel of Battery Module

Loosen the screw on the right side of the 1U panel to open the plastic front panel.

Step 2: Disconnect the Battery Connectors

Step 3: Loosen Eight Screws to Remove the Battery Compartment Covers

Step 4: Pull Out the Battery Packs

Pull the battery packs out slowly onto a flat and stable surface. Set them aside for reinstalling after that the EBM is rack-mounted.

1

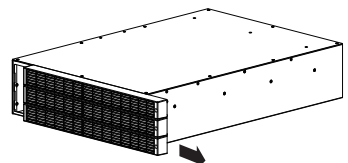
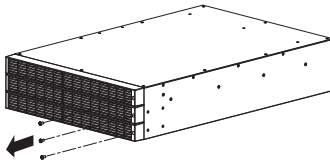

2

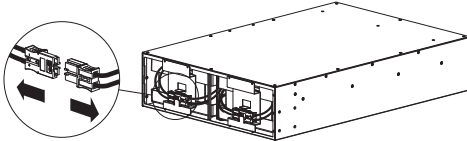

3

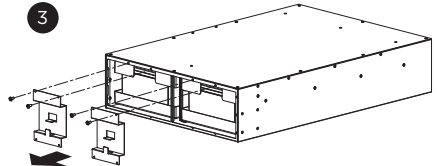

4

*battery packs of
BPS240V7ART3U/ BPS240V9ART3U

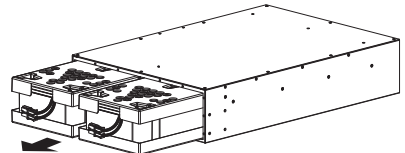

*battery packs of
BPS192V7ART3U/ BPS192V9ART3U

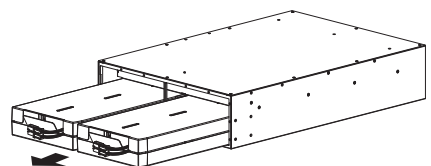

MAINTENANCE

Step 5: Re-install the Battery Packs

Step 5-1 : Put the new battery trays into the compartment.

Step 5-2 : Re-install the battery compartment cover and the plastic sheet by tightening the screws. Please make sure the connection is properly seated.

Step 5-3 : Connect the battery connectors and secure them to the battery compartment.

Step 5-4 : Re-install the front panels and tighten them with screws.

5-1 *battery packs of
BPS240V7ART3U/ BPS240V9ART3U

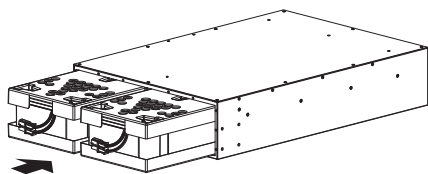

*battery packs of
BPS192V7ART3U/ BPS192V9ART3U

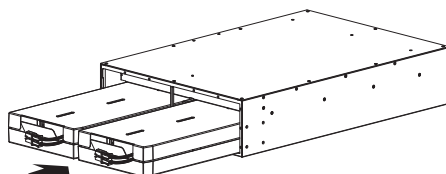

5-2

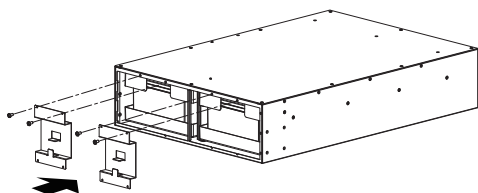

5-3

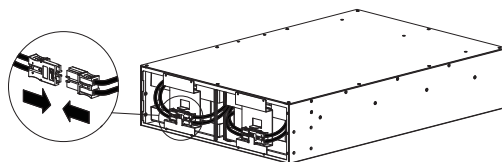

5-4

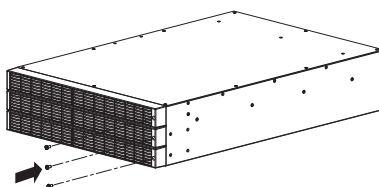
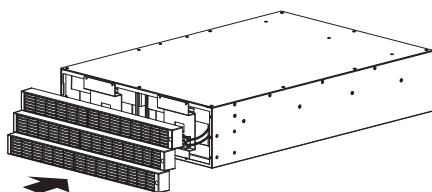

TECHNICAL SPECIFICATIONS

Models	BPS240V7ART3U	BPS240V9ART3U	BPS192V7ART3U	BPS192V9ART3U
CONFIGURATION				
DC Output Voltage	240 Vdc		192 Vdc	
PHYSICAL				
Dimensions (mm)	W x H x D = 433 x 127.8 x 660			
Net Weight (kgs)	55	66	47	55
BATTERY				
Specifications	12V x 20 pcs		12V x 16 pcs	
ENVIRONMENT				
Operating Temperature	32 °F to 104 °F (0 °C to 40 °C)			
Operating Relative Humidity	0 to 90% Non-Condensing			

Cyber Power Systems, Inc.

www.cyberpower.com

11F., No.26, Jinzhuang Rd., Neihu Dist., Taipei City 114, Taiwan

Copyright © 2023 Cyber Power Systems, Inc. All rights reserved.

CyberPower and the CyberPower logo are trademarks of Cyber Power Systems, Inc., and/or affiliates, which are registered in many countries and regions.

All other trademarks are the property of their respective owners.

