

## XFP-10GB-DW30-100-AO

MSA and TAA 10GBase-DWDM 100GHz XFP Transceiver (SMF, 1553.33nm, 100km, LC, DOM)

### Features

- INF-8077i Compliance
- Temperature-stabilized EML transmitter and PIN receiver
- Duplex LC Connector
- Commercial Temperature 0 to 70 Celsius
- Single-mode Fiber
- Hot Pluggable
- Excellent ESD Protection
- Metal with Lower EMI
- RoHS Compliant and Lead Free



### Applications

- 8x/10x Fibre Channel
- 10x Gigabit Ethernet over DWDM
- Access, Metro and Enterprise

### Product Description

This MSA Compliant XFP transceiver provides 10GBase-DWDM throughput up to 100km over single-mode fiber (SMF) using a wavelength of 1553.33nm via an LC connector. It is built to MSA standards and is uniquely serialized and data-traffic and application tested to ensure that they will integrate into your network seamlessly. Digital optical monitoring (DOM) support is also present to allow access to real-time operating parameters. This transceiver is Trade Agreements Act (TAA) compliant. We stand behind the quality of our products and proudly offer a limited lifetime warranty.

AddOn's transceivers are RoHS compliant and lead-free.

TAA refers to the Trade Agreements Act (19 U.S.C. & 2501-2581), which is intended to foster fair and open international trade. TAA requires that the U.S. Government may acquire only "U.S. – made or designated country end products."



## Regulatory Compliance

- ESD to the Electrical PINs: compatible with MIL-STD-883E Method 3015.4.
- ESD to the LC Receptacle: compatible with IEC 61000-4-3.
- EMI/EMC: compatible with FCC Part 15 Subpart B Rules, EN55022:2010.
- Laser Eye Safety: compatible with FDA 21CFR, EN60950-1& EN (IEC) 60825-1, 2.
- RoHS: compliant with EU RoHS 2.0 directive 2015/863/EU.

## Available Wavelengths

Channel #	Frequency (THz)	Center Wavelength (nm)
15	191.5	1565.50
16	191.6	1564.68
17	191.7	1563.86
18	191.8	1563.05
19	191.9	1562.23
20	192.0	1561.42
21	192.1	1560.61
22	192.2	1559.79
23	192.3	1558.98
24	192.4	1558.17
25	192.5	1557.36
26	192.6	1556.55
27	192.7	1555.75
28	192.8	1554.94
29	192.9	1554.13
30	193.0	1553.33
31	193.1	1552.52
32	193.2	1551.72
33	193.3	1550.92
34	193.4	1550.12
35	193.5	1549.32
36	193.6	1548.51
37	193.7	1547.72
38	193.8	1546.92
39	193.9	1546.12
40	194.0	1545.32
41	194.1	1544.53
42	194.2	1543.73

43	194.3	1542.94
44	194.4	1542.14
45	194.5	1541.35
46	194.6	1540.56
47	194.7	1539.77
48	194.8	1538.98
49	194.9	1538.19
50	195.0	1537.40
51	195.1	1536.61
52	195.2	1535.82
53	195.3	1535.04
54	195.4	1534.25
55	195.5	1533.47
56	195.6	1532.68
57	195.7	1531.90
58	195.8	1531.12
59	195.9	1530.33
60	196.0	1529.55
61	196.1	1528.77

### Absolute Maximum Ratings

Parameter	Symbol	Min.	Max.	Unit
Storage Temperature	T <sub>stg</sub>	-40	85	°C
Operating Temperature	T <sub>c</sub>	0	70	°C
Operating Humidity	RH		95	%
Maximum Supply Voltage	V <sub>cc</sub>	-0.5	3.6	dBm
Maximum Bitrate	B <sub>max</sub>		11.3	Gbps

## Electrical Characteristics

Parameter	Symbol	Min.	Typ.	Max.	Unit	Notes
Power Budget			25		dB	
Data Rate			9.953 10.3125		Gbps	
<b>Transmitter</b>						
CML Differential Inputs	VIN	150		1200	mVp-p	1
Input AC Common-Mode Voltage		0		25	mV	2
Input Differential Impedance	ZIN	85	100	115	$\Omega$	3
Tx_Disable	High		2		Vcc	V
	Low		0		0.8	V
Tx_Fault	High		2		Vcc+0.3	V
	Low		0		0.5	V
<b>Receiver</b>						
CML Differential Outputs	VOUT	350		700	mVp-p	6
Output Differential Impedance	ZOUT	85	100	115	$\Omega$	
Rx_LOS	High		2		Vcc+0.3	4
	Low		0		0.8	5
MOD_DEF (0.2)		VOH	2.5		V	6
		VOL	0		0.5	V

### Notes:

1. AC coupled inputs.
2. RMS.
3.  $R_{in} > 100k\Omega$  @DC.
4.  $I_o = 400\mu A$ . Host\_Vcc.
5.  $I_o = -4.0mA$ .
6. AC coupled outputs.
7. With serial ID.

## Optical Characteristics

Parameter	Symbol	Min.	Typ.	Max.	Unit	Notes
<b>Transmitter</b>						
Operating Wavelength	$\lambda_C$	$\lambda_C-0.1$	$\lambda_C$	$\lambda_C+0.1$	nm	
Spectral Width (-20dB)	$\Delta\lambda$			1	nm	
Average Output Power	POUT	1		5	dBm	1
Extinction Ratio	ER	8.2			dB	
Average Power of Off Transmitter	Poff			-30	dBm	
Relative Intensity Noise	RIN			-128	dB/Hz	
Side-Mode Suppression Ratio	SMSR	30			dB	
Transmitter Dispersion Penalty	TDP			5	dB	
Tx_Disable Assert Time	T_off			10	us	
<b>Receiver</b>						
Center Wavelength	$\lambda_C$	1260	1550	1600	nm	
Receiver Sensitivity	Pmin			-24	dBm	2
Receiver Overload	Pmax	-7			dBm	
LOS De-Assert	LOSD			-26	dBm	
LOS Assert	LOSA	-38			dBm	
LOS Hysteresis	LOSH	0.5			dB	

### Notes:

1. Output is coupled into a 9/125 $\mu$ m SMF.
2. Measured with worst ER: BER < 1E<sup>-12</sup> and PRBS 2<sup>31</sup>-1 @ 10.3125Gbps.

## Pin Descriptions

Pin	Symbol	Name/Description	Note
1	GND	Module Ground.	
2	Vee5	Optional. 5.2 Power Supply. Not Required.	
3	MOD_DESEL	Module De-Select. When held "low," allows the module to respond to 2-wire serial interface commands.	
4	Interrupt	Interrupt Output. Indicates the presence of an important condition which can be read over the 2-wire serial interface.	
5	Tx_Disable	Transmitter Disable. Transmitter laser source is turned off.	
6	Vcc5	+5 Power Supply. Not Required.	
7	GND	Module Ground.	
8	Vcc3	+3.3V Power Supply.	
9	Vcc3	+3.3V Power Supply.	
10	SCL	2-Wire Serial Interface Clock.	
11	SDA	2-Wire Serial Interface Data.	
12	MOD_ABS	Module Absent. Indicates that the module is not present. Grounded in the module.	
13	MOD_NR	Module is Not Ready.	
14	Rx_LOS	Receiver Loss of Signal Indicator.	
15	GND	Module Ground.	
16	GND	Module Ground.	
17	RD-	Receiver Inverted Data Output.	
18	RD+	Receiver Non-Inverted Data Output.	
19	GND	Module Ground.	
20	Vcc2	+1.8V Power Supply. Not Required.	
21	P_Down/RST	Power Down. When "high," places the module in the low-power stand-by mode. The falling edge of P_Down initiates a module reset. Reset. The falling edge initiates a complete reset of the module including the 2-wire serial interface equivalent to a power cycle.	
22	Vcc2	+1.8V Power Supply. Not Required.	
23	GND	Module Ground.	
24	Ref CLK+	Reference Clock. Non-Inverted Input. AC coupled on the host board. Not Required.	
25	Ref CLK-	Reference Clock. Inverted Input. AC coupled on the host board. Not Required.	
26	GND	Module Ground.	
27	GND	Module Ground.	
28	TD-	Transmitter Inverted Data Input.	
29	TD+	Transmitter Non-Inverted Data Input.	
30	GND	Module Ground.	

## Electrical Pin-Out Details

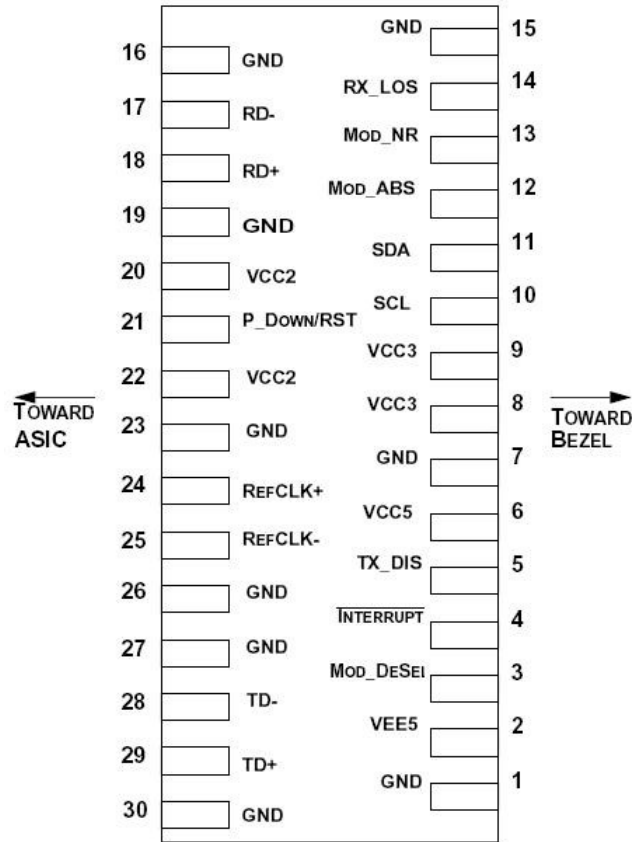

## Recommended Circuit Schematic

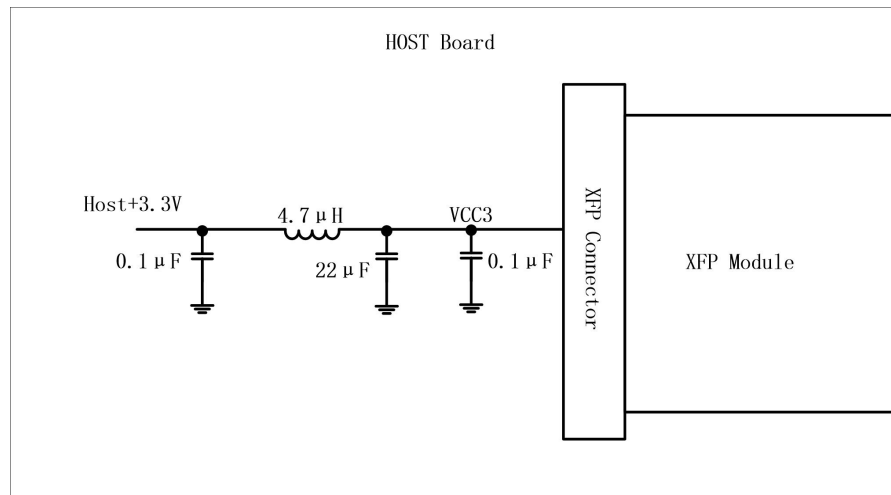

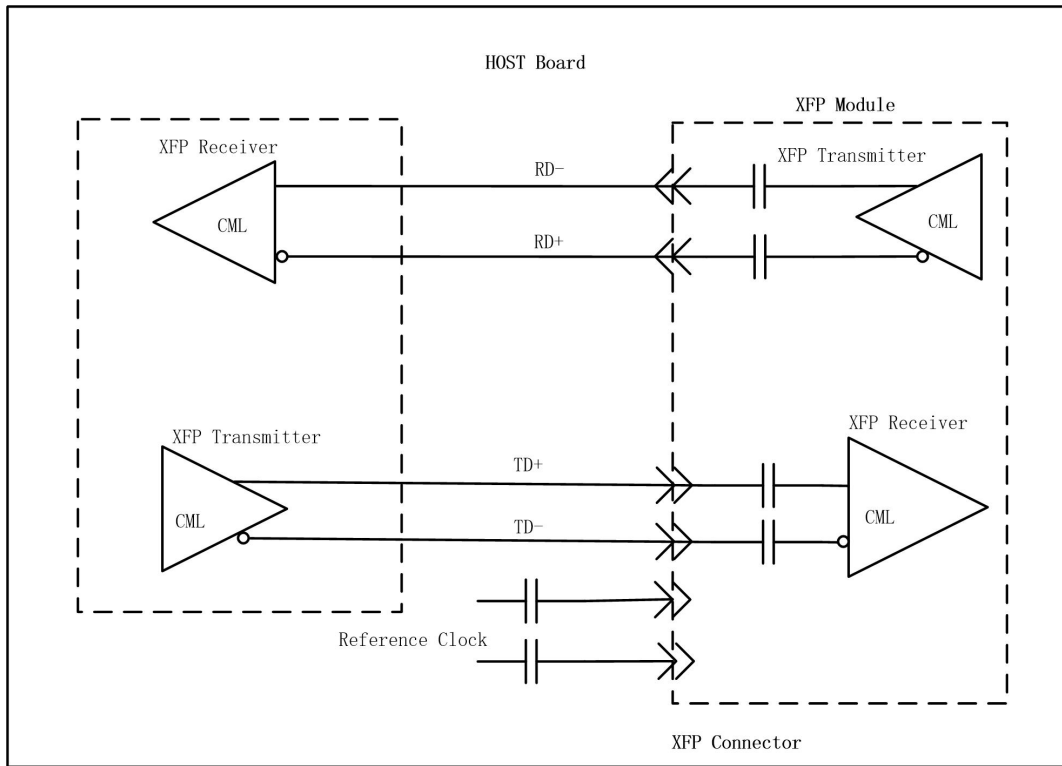

### Mechanical Specifications

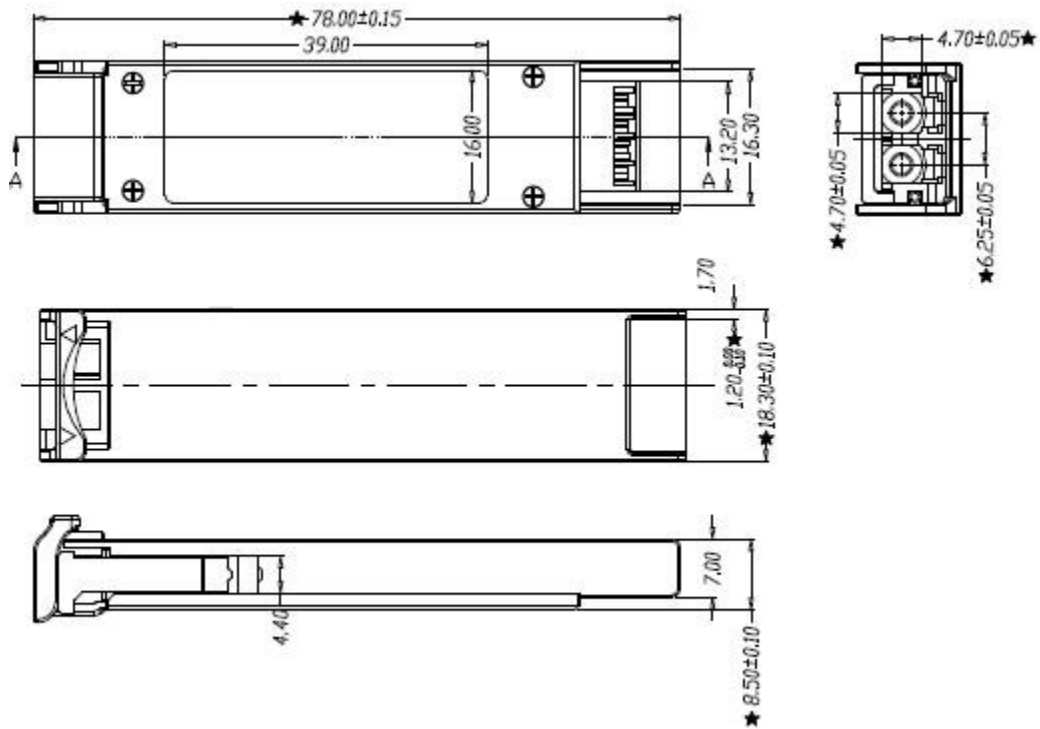



## **About AddOn Networks**

In 1999, AddOn Networks entered the market with a single product. Our founders fulfilled a severe shortage for compatible, cost-effective optical transceivers that compete at the same performance levels as leading OEM manufacturers. Adhering to the idea of redefining service and product quality not previously had in the fiber optic networking industry, AddOn invested resources in solution design, production, fulfillment, and global support.

Combining one of the most extensive and stringent testing processes in the industry, an exceptional free tech support center, and a consistent roll-out of innovative technologies, AddOn has continually set industry standards of quality and reliability throughout its history.

Reliability is the cornerstone of any optical fiber network and is engrained in AddOn's DNA. It has played a key role in nurturing the long-term relationships developed over the years with customers. AddOn remains committed to exceeding industry standards with certifications from ranging from NEBS Level 3 to ISO 9001:2005 with every new development while maintaining the signature reliability of its products.

## **U.S. Headquarters**

Email: [sales@addonnetworks.com](mailto:sales@addonnetworks.com)

Telephone: +1 877.292.1701

Fax: 949.266.9273

## **Europe Headquarters**

Email: [salesupportemea@addonnetworks.com](mailto:salesupportemea@addonnetworks.com)

Telephone: +44 1285 842070